

POWER METER

# D1M 20

## User manual

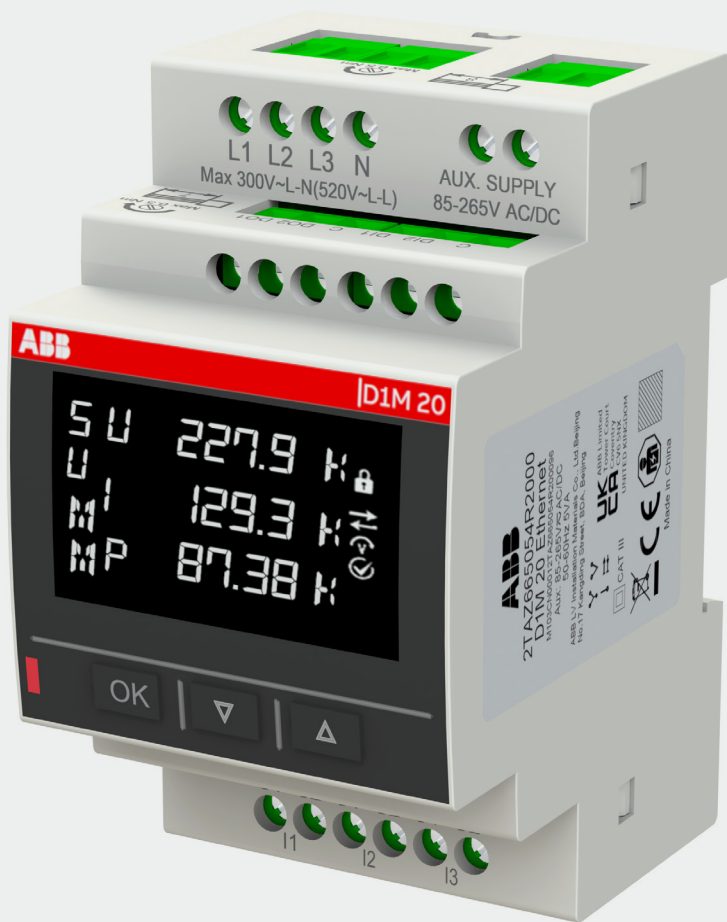



# Table of Contents

<b>1. General information.....</b>	<b>5</b>
1.1.Use and storage of manuals.....	5
1.2.Copyright .....	5
1.3.Liability disclaimer .....	5
1.4.General safety warnings .....	5
1.5.Cyber Security Disclaimer.....	6
<b>2. Packaging contents .....</b>	<b>7</b>
<b>3. Technical characteristics .....</b>	<b>8</b>
3.1.Description of the device .....	8
3.2.Main functionalities.....	8
3.3.Versions.....	8
3.4.Overall dimensions .....	9
3.5.Technical data.....	9
<b>4. Installation .....</b>	<b>12</b>
4.1.Assembly.....	12
4.2.Disassembly.....	12
4.3.Wiring diagrams.....	13
<b>5. Access to device.....</b>	<b>15</b>
5.1.Display .....	15
5.2.Buttons .....	17
5.3.Data entry.....	18
<b>6. First commissioning.....</b>	<b>21</b>
6.1.Password for the first use (PWD).....	21
6.2.Real Time Clock (RTC) .....	22
6.3.Wiring (WIR) .....	23
6.4.CT ratio (CT) .....	23
6.5.VT ratio (VT).....	24
<b>7. Configuration (CONF).....</b>	<b>25</b>
7.1.Unit (UNIT) .....	25
7.2.Installation (ISTL) .....	33
7.3.Input/output (I/O) .....	33
7.4.Alarms (ALAM) .....	36
7.5.Tariff (TARF).....	41
7.6.Communication (COMM) .....	47
7.7.Other (OTHR) .....	51

- 8. Data reading (READ)..... 53**
  - 8.1.Realtime (REAL) ..... 54
  - 8.2.Energy (ENRG) .....55
  - 8.3.Power Quality (PWQT).....57
  - 8.4.Average values (AVG) ..... 58
  - 8.5.Maximum values (MAX) .....59
  - 8.6.Minimum values (MIN) ..... 60
  - 8.7.I/O ..... 61
  - 8.8.Notifications (NOTF).....62
  - 8.9.Power Outage (PWOFF) ..... 65
  - 8.10.Timers (TIME)..... 65
  
- 9. Conclusion .....66**

---

# 1. General information

---

## 1.1. Use and storage of manuals

Carefully read this manual and adhere to the indications described prior to using the device.

This manual contains all of the safety information, the technical aspects and the operations necessary to ensure the correct use of the device and maintain it in safe conditions.

---

## 1.2. Copyright

The copyright of this manual is the property of **ABB LV Installation Materials Co. Ltd. Beijing**. This manual contains texts, designs and illustrations of a technical nature which must not be disclosed or transmitted to third parties, even partially, without the written authorization of **ABB LV Installation Materials Co. Ltd. Beijing**.

---

## 1.3. Liability disclaimer

The information contained in this document is subject to change without notice and cannot be considered as an obligation by **ABB LV Installation Materials Co. Ltd. Beijing**. **ABB LV Installation Materials Co. Ltd. Beijing** is not liable for any errors that may appear in this document. **ABB LV Installation Materials Co. Ltd. Beijing** is not liable under any circumstances for any direct, indirect, special, incidental or consequential damage of any kind that may arise from using this document. **ABB LV Installation Materials Co. Ltd. Beijing** is also not liable for incidental or consequential damage that may arise from using the software or hardware mentioned in this document.

---

## 1.4. General safety warnings



Non-adherence to the following points can lead to serious injury or death.

Use the suitable personal protection devices and adhere to the current regulations governing electrical safety.

- This device must be installed exclusively by qualified personnel who have read all of the information relative to the installation.
- Check that the voltage supply and measurement are compatible with the range permitted by the device.
- Ensure that all current and voltage supplies are disconnected prior to carrying out any controls, visual inspections and tests on the device.
- Always assume that all circuits are under voltage until they are completely disconnected, subjected to tests and labelled.
- Disconnect all of the power supply prior to working on the device.
- Always use a suitable voltage detection device to check that the supply is interrupted.
- Pay attention to any dangers and carefully check the work area ensuring that no instruments or foreign objects have been left inside the compartment in which the device is housed.
- The correct use of this device depends on a correct manipulation, installation and use.
- Failure to adhere to the basic installation information can lead to injuries as well as damage to the electric instruments or to any other product.
- **NEVER** connect an external fuse in by-pass.
- Disconnect all of the input and output wires before carrying out a dielectric rigidity test or an insulation test on an instrument in which the device is installed.
- The tests carried out at a high voltage can damage the device's electronic components.
- The device has to be installed on a standard 35mm DIN rail.
- Installation of D1M shall include a switch or circuit breaker for the connection of auxiliary supply and voltage measurement. The switch or circuit breaker must be suitably located and easily reachable and must be marked as the disconnecting device for D1M.
- Before connecting the auxiliary power supply and voltage measurement, or disconnecting the auxiliary power supply or voltage measurement, you must turn off the circuit breaker or switch.

---

## 1.5. Cyber Security Disclaimer

D1M 20 multimeter is designed to be connected and to communicate information and data via a network interface, which should be connected to a secure network. It is your sole responsibility to provide and continuously ensure a secure connection between the product and your network or any other network (as the case may be) and to establish and maintain appropriate measures (such as but not limited to the installation of firewalls, application of authentication measures, encryption of data, installation of antivirus programs, etc.) to protect the D1M 20 multimeter product, the network, its system and interfaces against any kind of security breaches, unauthorized access, interference, intrusion, leakage and/or theft of data or information. **ABB LV Installation Materials Co. Ltd. Beijing** and its affiliates are not liable for damages and/ or losses related to such security breaches, unauthorized access, interference, intrusion, leakage and/or theft of data or information.

D1M products can only work on a Local Area Network, it uses Modbus communication which is unsafe protocol, so you should establish a safe hardware environment for meter operation to against security threats or attacks. We recommend that you change your security password in time, keep the meter is not accessible to irrelevant personnel, and deploy security measures such as installing firewall and anti-virus software.

Although **ABB LV Installation Materials Co. Ltd. Beijing** provides functionality testing on the products and updates that we release, you should institute your own testing program for any product updates or other major system updates (to include but not limited to code changes, configuration file changes, third party software updates or patches, hardware change out, etc.) to ensure that the security measures that you have implemented have not been compromised and system functionality in your environment is as expected.

## 2. Packaging contents

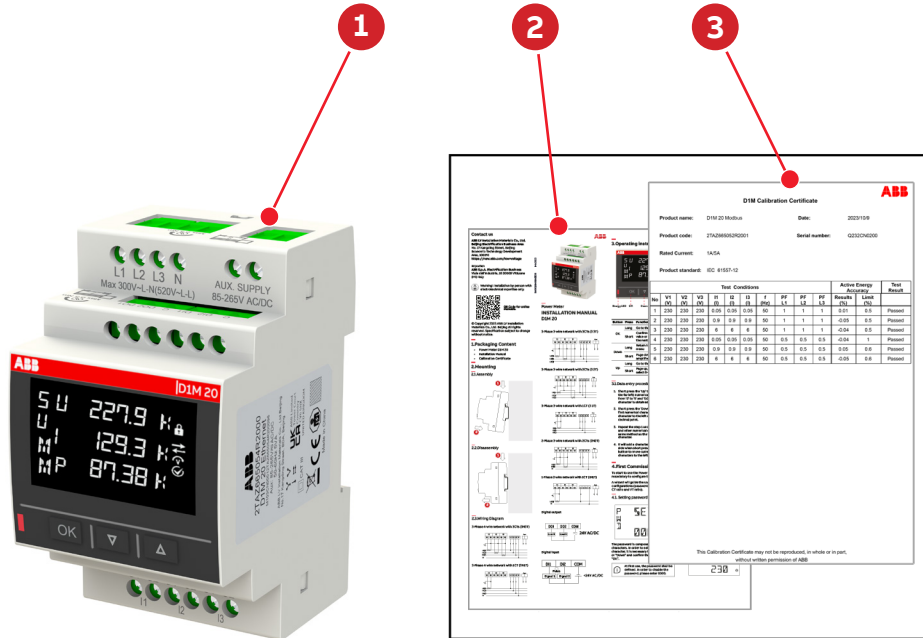

### Packaging contents

1	Power meter D1M 20
2	Installation manual
3	Calibration certificate

## 3. Technical characteristics

### 3.1. Description of the device

D1M series can help users accurately monitor energy efficiency while meeting their cost control requirement.

Conforming to the international electric energy metering and monitoring accuracy standards, all D1M series products are perfectly suitable for ABB electrical systems and solutions.

### 3.2. Main functionalities

<b>Real-time Measurement</b>	
TRMS Current	●
TRMS Voltage	●
Frequency	●
Active, Reactive and Apparent Power	●
Power Factor	●
Operating timer, countdown timer	●
<b>Energy</b>	
Active, Reactive and Apparent Energy	●
Four-quadrant (Import/Export/Net)	●
Tariffs	●
CO <sub>2</sub> of active energy Import	●
Currency of active energy Import	●
<b>Power quality</b>	
THD (I, VLN, VLL)	●
Individual harmonics	40th
Unbalances (I, VLN, VLL)	●
Neutral current	Calculated
<b>Data recording and logs</b>	
Alarms	15
Warnings logs	●
Alarm logs	●
Error logs	●
Audit logs	●
Average/Maximum/Minimum value	●
Power outage logs	●
RTC	●

### 3.3. Versions

<b>Product Name</b>	<b>I/O</b>	<b>Communication protocol</b>
D1M 20 Modbus	2 DO+2 DI	Modbus RTU
D1M 20 Ethernet	2 DO+2 DI	Modbus TCP/IP



### 3.4. Overall dimensions

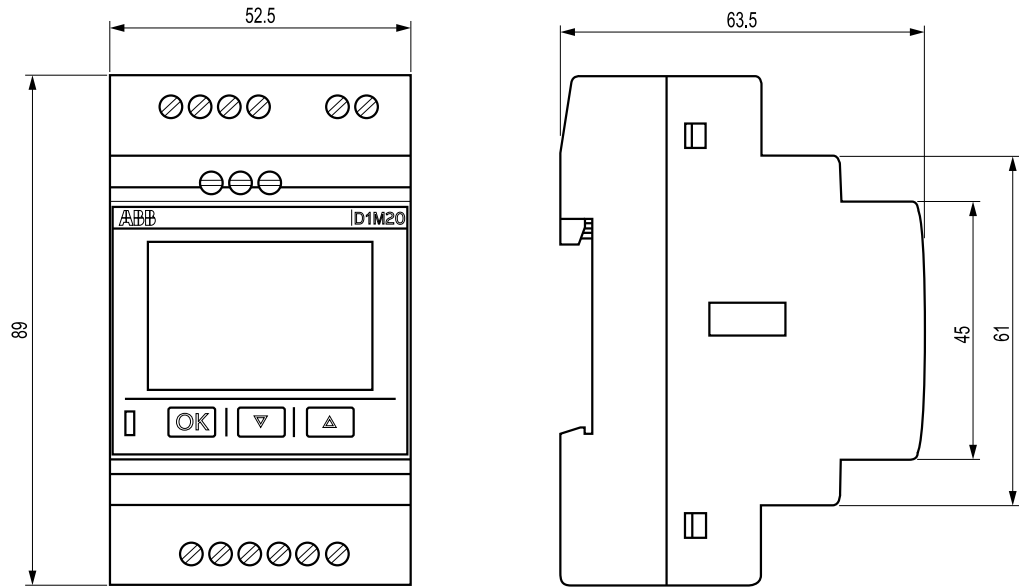

Unit: mm

### 3.5. Technical data

<b>Auxiliary power supply</b>	
Voltage range	100-230 V AC/DC $\pm 15\%$
Frequency	50 - 60Hz $\pm 5\%$
Power Consumption	5VA max
Installation category	CAT III 300V class per IEC 61010-1 edition 3
Protection fuse	T1 A-277 VAC
<b>Measurement accuracy</b>	
IEC 61557-12	IEC 61557-12 PMD/S/K55/0.5
Active energy	IEC61557-12 Class 0.5
	IEC 62053-22 Class 0.5S
Reactive energy	IEC61557-12 Class 1
	IEC 62053-24 Class 1
Active power	IEC 61557-12 Class 0.5
Reactive power	IEC 61557-12 Class 1
Apparent power	IEC 61557-12 Class 1
Voltage	IEC 61557-12 Class 0.5
Current	IEC 61557-12 Class 0.5
Neutral Current (calculated)	IEC 61557-12 Class 1
Frequency	IEC 61557-12 Class 0.1
Unbalance	IEC 61557-12 Class 0.5
THD, Harmonics(current, voltage)	IEC 61557-12 Class 5

<b>Voltage measurement inputs</b>	
Voltage input mode	Direct or Indirect insertion with VT
Measurement Range	80-300 VAC(L-N)
Wiring Type	Single-phase, three-phase (3P, 3P+N)
Rated frequency	50Hz or 60Hz
VT primary range	50~750000V
VT secondary range	50~510V
Individual harmonics	2nd~40th, 0%~50%

<b>Current measurement inputs</b>	
Current input mode	Indirect insertion with CT
Wiring Type	Single-phase, three-phase (3P, 3P+N)
CT secondary range	1A or 5A
Rated frequency	50Hz or 60Hz
Range without accuracy derating	50mA-5A AC 120%
CT primary range	1-50000A
Wiring Type	Single-phase, three-phase (3P, 3P+N)
Individual harmonics	2nd~40th, 0%~50%

<b>Digital Input</b>	
Number of channels	2
Voltage	24 VDC
Frequency	<1kHz

<b>Digital Output</b>	
Number of channels	2
Voltage	24 VAC/DC
Current	≤100mA DC
Width	10 ~ 990ms

<b>Mechanical properties</b>	
Overall Dimensions	89.0mm x 52.5mm x 63.5mm
IP degree of protection (IEC 60529)	Front: IP51 Terminals: IP20
Max. weight	259g
Fireproof and Heatproof	Terminal 960°C, cover 650°C

<b>Climatic conditions</b>	
Operating temperature	-5 to 55°C (K55 IEC61557-12)
Storage temperature	-25 to 70°C (K55 IEC61557-12)
Relative humidity	≤75% yearly average ≤95% on 30 days/year
Altitude	≤2Km
Pollution degree	2
Environment	It is prohibited to use in the environment containing H <sub>2</sub> S, Cl <sub>2</sub> , NH <sub>3</sub> and other harmful gases

<b>Communication protocol</b>	
<b>Modbus RTU</b>	<b>D1M 20 Modbus</b>
Communication interface	RS485 with optical isolation
Baud rate	9.6, 19.2, 38.4, 57.6, 115.2 kbps
Parity number	Odd (1 stop bit), Even (1 stop bit), None (1 stop bits)
Address	1-247
Connector	3 pole terminal

<b>Modbus TCP/IP</b>	<b>D1M 20 Ethernet</b>
Communication protocol	Modbus TCP/IP
Communication interface	RJ45
IP Address	DHCP/Manual, default 192.168.1.12
Subnet mask	DHCP/Manual, default 255.255.255.0
Gateway	DHCP/Manual, default 192.168.1.1
Port	502 fixed

<b>Standards</b>	
Power metering and monitoring devices (PMD)	IEC 61557-12
Static meters for AC active energy	IEC 62053-22
Static meters for fundamental component reactive energy	IEC 62053-24
EMC	IEC 61326-1
Electrical safety	IEC 61010-1
IP degree of protection	IEC 60529

---

## 4. Installation

---

### 4.1.Assembly

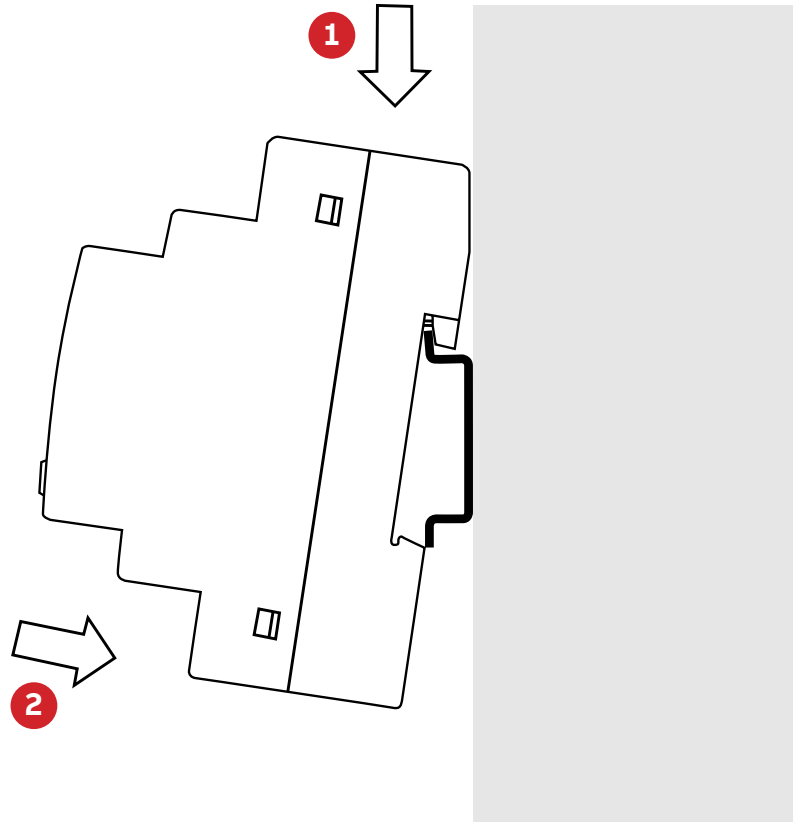

---

### 4.2.Disassembly

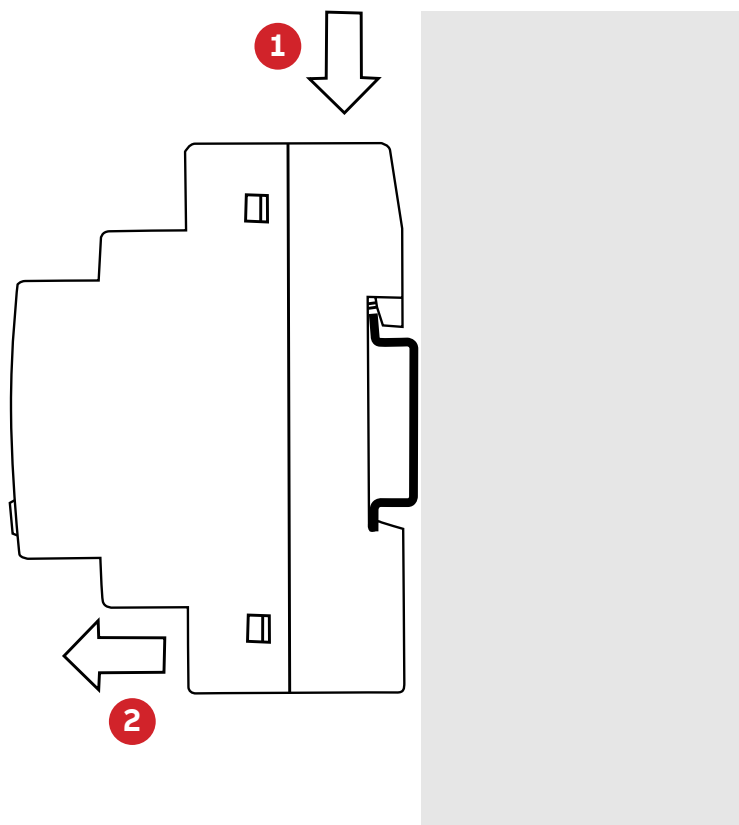

### 4.3. Wiring diagrams

The operations to carry out for the correct connection of the device, based on the type of electric line available, are described in this section.

The installation and the cabling of the device must be carried out by qualified personnel.

Danger of electrocution, burning and electric arc.

Use the personal protection devices suitable to adhere to the current regulations governing electrical safety.

Prior to carrying out any connections check the sectioning of the electric supply with the voltage detection device.

#### D1M 20 Modbus



#### D1M 20 Ethernet



### Type of network

D1M 20 can be used on different type of network (please refer to chapter “7. Configuration (CONF)” for the configuration on the device). According to the type of network that has been chosen, the parameters visualized on the device HMI change. Below the wiring diagrams are shown:

#### • 3-phase 4-wire network with 3CTs (3N3T)

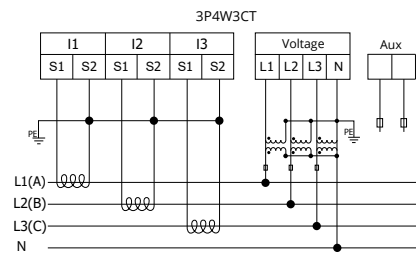
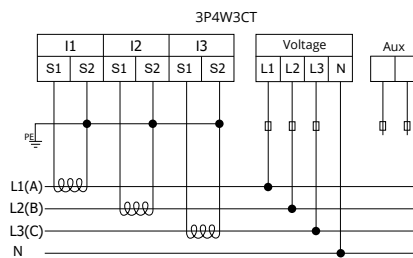

#### • 3-phase 4-wire network with 1CT (3N1T)

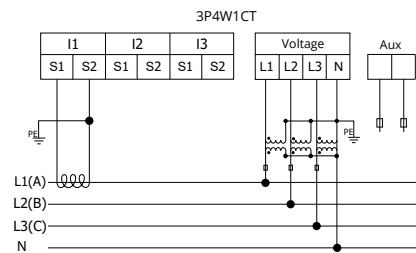
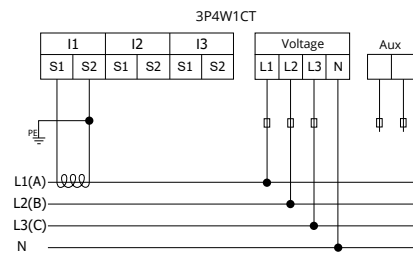

• 3-phase 3-wire network with 3CTs (3 3T)

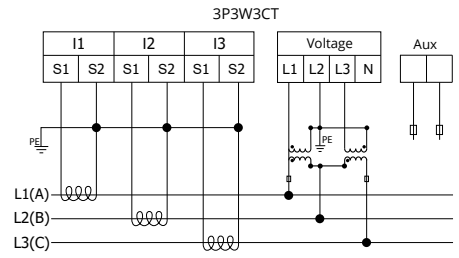
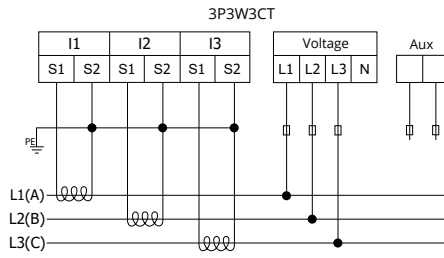

• 3-phase 3-wire network with 2CTs (3 2T)

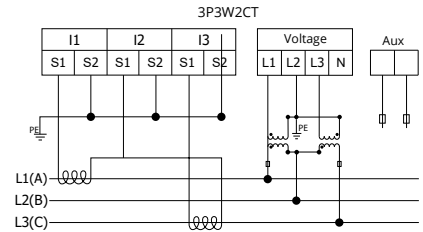
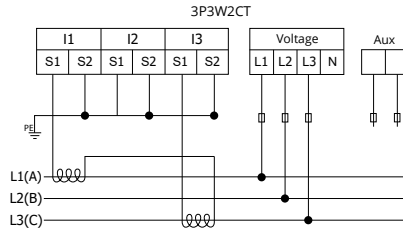

• 3-phase 3-wire network with 1CT (3 1T)

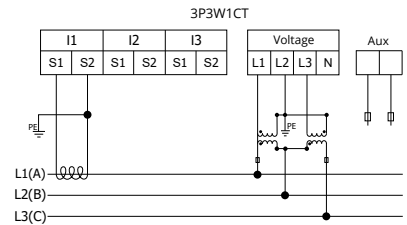
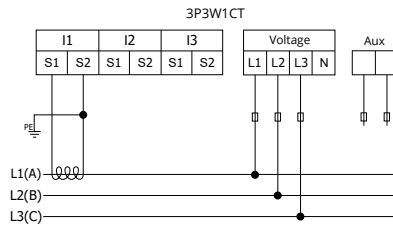

• 2-phase 3-wire network with 2CTs (2N2T)

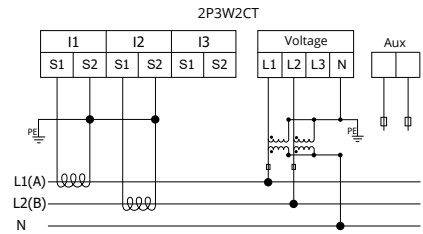
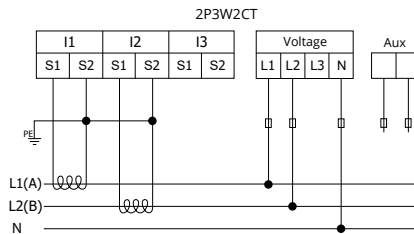

• 1-phase 2-wire network with 1CT (1N1T)

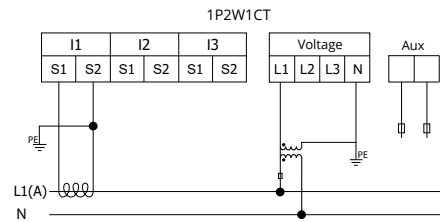
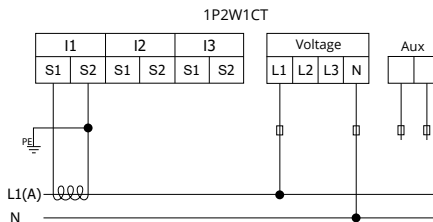

• Digital outputs and digital inputs

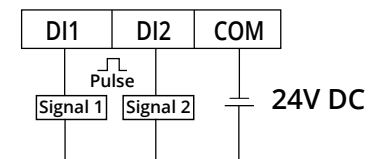
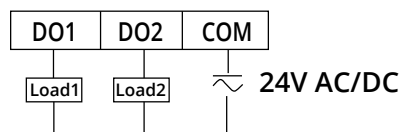

## 5. Access to device

This chapter gives a detailed introduction of the device's HMI, including how to read data and configure related parameters.

### 5.1.Display

Front panel.

D1M 20 products use LCD displayer, the front panel of D1M 20 is shown below:

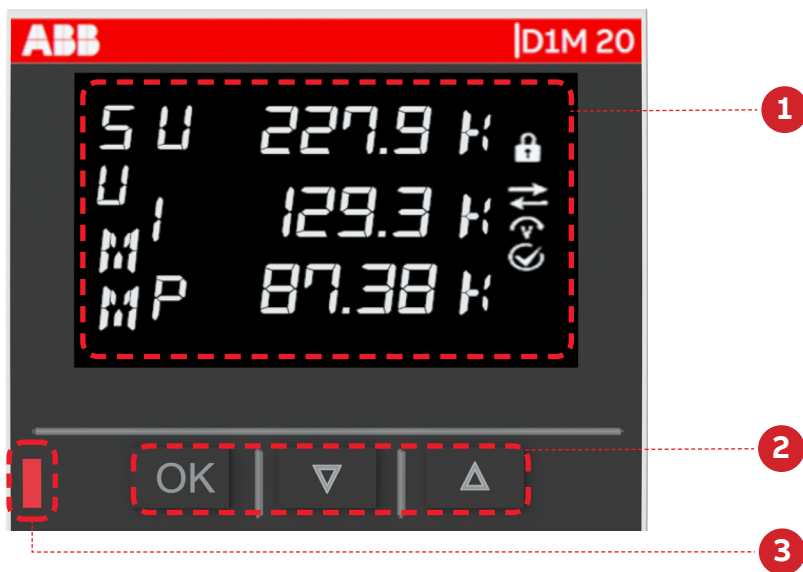

Operator panel	
1	Display area
2	Function buttons
3	Energy pulse LED





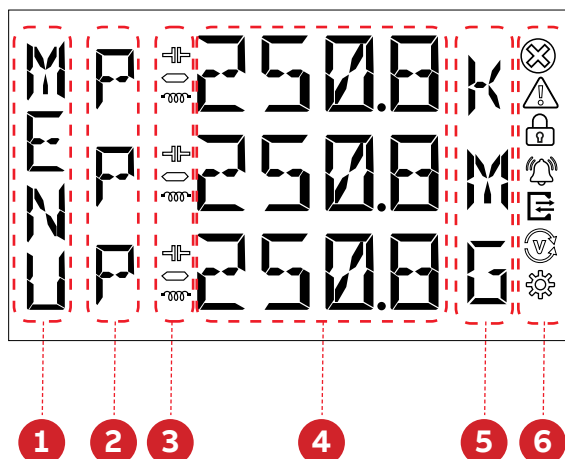



#### Display content

Display is divided into 6 different areas, as shown in the figure below:



N	Area	Description
1	Title	Title of the content displayed on each screen
2	Phase	The corresponding phase of the measured value displayed, such as L1, L2, L3, L12 and L23...
3	Load type	Inductive load and capacitive load, or the negative sign
4	Measurements	Specific measured value, or other contents
5	Magnitude	Magnitude includes E, K and M
6	Icons	Indicating various types of state, and for further details, see the table below



**Icon description:**

Icon	Description
	Notification of alarm
	Voltage correct phase sequence
	Voltage reverse phase sequence
	Notification of error
	Communication signals sent
	Communication signals received
	Configure parameters
	Device locked, and parameters non-configurable
	Notification of warning

**Character display type:**

Area	Type
Title	A B C D E F G H I J K L
	A B C D E F G H I J K L
Measurements	M N O P Q R S T U V W X
	M N O P Q R S T U V W X
	Y Z 0 1 2 3 4 5 6 7 8 9
	Y Z 0 1 2 3 4 5 6 7 8 9



	A B C D E F G H I J K L A B C D E F G H I J K L
Phase	P Q R S T U V W X M N O P Q R S T U V W X Y Z 0 1 2 3 4 5 6 7 8 9 Y Z 0 1 2 3 4 5 6 7 8 9
Magnitude	V A W K M G R H Z
Load type	  

### 5.2. Buttons

Each D1M 20 is provided with 3 push buttons as per below picture:

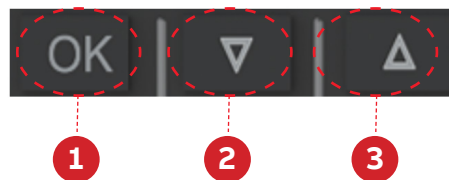

Functions of each button might change according to the displayed page on the meter. See below for a complete description:

#	Button	Short press functions	Long press functions
1	OK	Confirm the numerical value or option input, go to the next level menu	Go to the main menu
2	Down	Page down, numerical value amplifies 10 times	Return to the previous level menu
3	Up	Page up, numerical value select 0~9 and decimal point	Go to the Home page

There are some functions need to use combination of pushbuttons, see below for a complete description:

Combination buttons	Screen	Function
Down + Up	During entering password	Short press together to escape password check configuration read-only.

### 5.3.Data entry

Some of the pages require the entry of numerical characters (0-9) in the Configuration mode. In these cases, the display will show an active field identified by a flashing number.

#### Data entry procedure

Press the “OK” button to start setting on the specified parameter page, and the parameter starts to blink display.

The data entry procedure is as follows:

- Short press the “Up” Arrow button to set the first(on the far left) numerical character in a loop from “0” to “9” and “0.0”, until the required character is obtained.
- Short press the “Down” Arrow button to confirm the first numerical character and move this character to the left, or confirm the first decimal point.
- Repeat the step 1 and 2 to set the second and other numerical characters, it’s the same method as the first numerical character.
- It will add a character “0” on the right side when short press the “Down” Arrow button to move current numerical characters to the left.

The following will be combined with the display to describe how to complete the data entry.

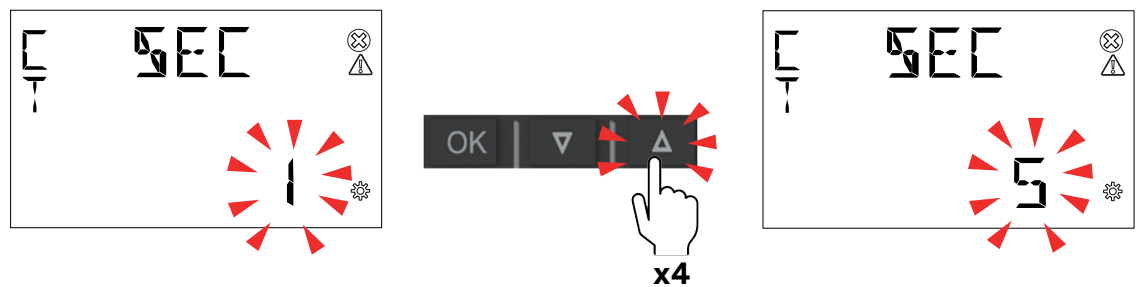

1. Press “Up” to increase the numerical characters from 0 to 9, until the required character is obtained.

#### • How to Go back to a previous number

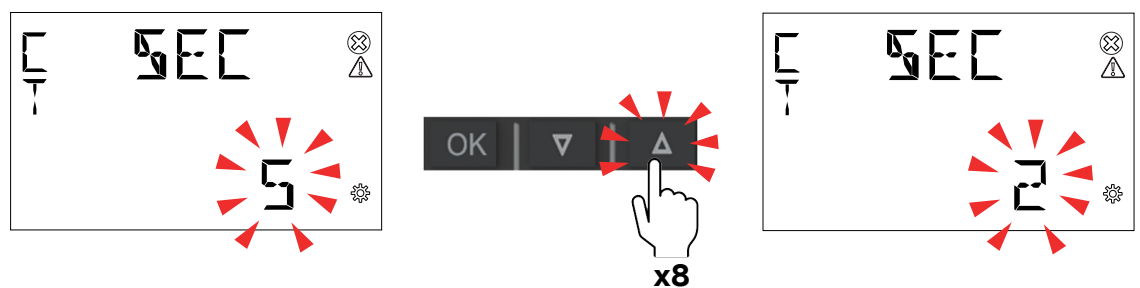

If during the data entry the desired number is exceeded by mistake, it is needed to increase the displayed number until data entry starts again from 0.

#### • Add a second digit

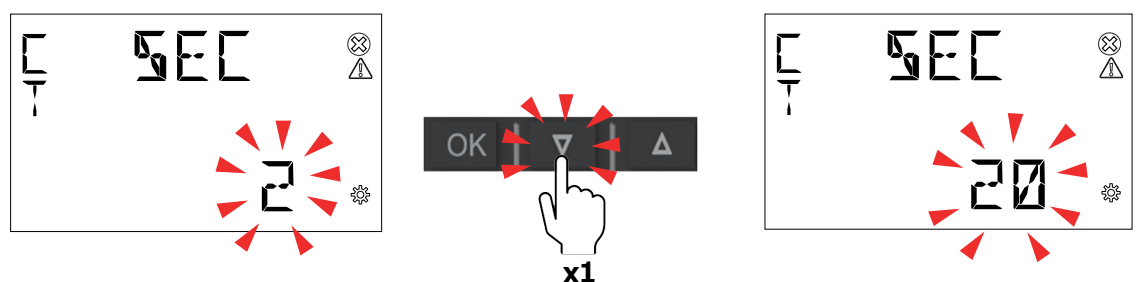

2. Press “Down” to move the cursor in order to add a second digit to the number.

• How to: Enable the comma

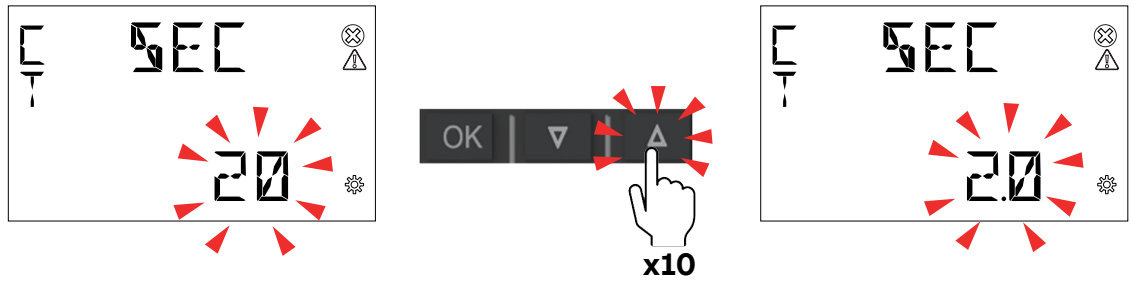

Some device configurations allow entering the comma. Comma can be displayed by increasing the number with “Up”, after character 9 and before data entry starts again from character 0.

• Confirm number

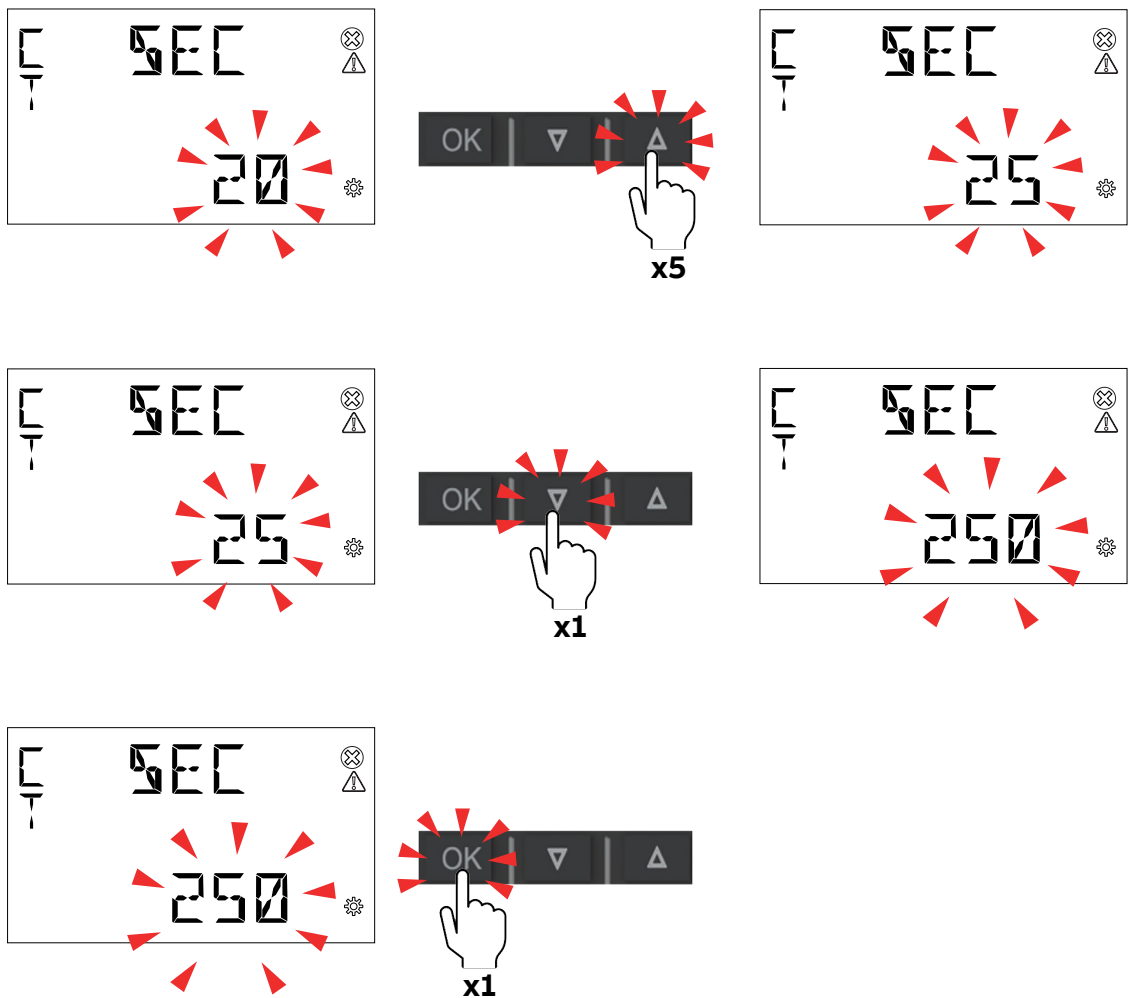

3. Repeat the operations described in steps 1 and 2 until the desired number is obtained, press “OK” to confirm the number.

- **How to Enter the magnitude**

Some device configurations allow entering the magnitude (k, M). Once the number has been entered as after step 3, keys “Up” and “Down” allow enabling the magnitude “K” (kilo) or not. Press “OK” to confirm the magnitude. Follow the steps below when the buttons are used to enter numbers:

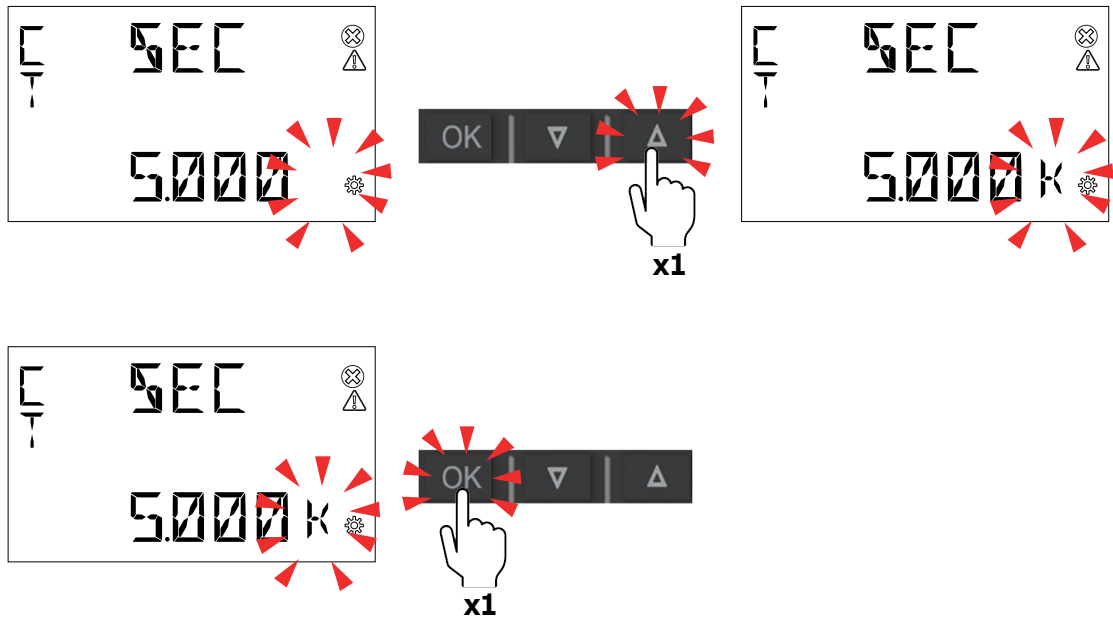

## 6. First commissioning

When the device is started up for the first time, the basic parameters need to be set, and the wizard program will guide the user to configure the device by following the steps below:

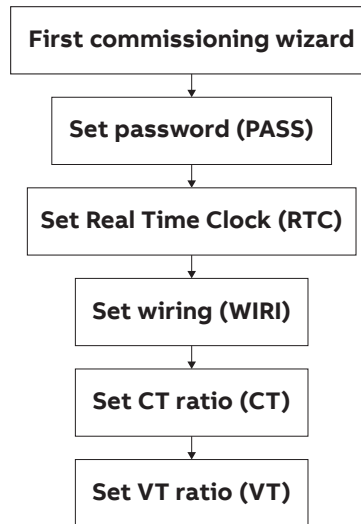

### 6.1.Password for the first use (PWD)

A password can be set by the user to protect the Configuration menu and avoid any unwanted modification to the device settings.

At the first use it is mandatory to define a password.

The password comprises 4 digits, and Button “Up” and Button “Down” can be used to enter numbers, and Button “OK” can be used to confirm the user’s settings and Button “Menu” used to drop the user’s settings.

In order to disable the password, please set the new password as 0000.

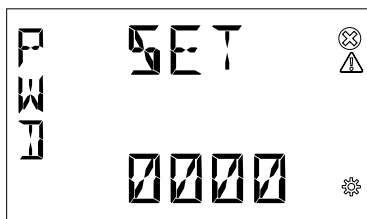

The password can be changed this way:

1. Go to **CFG>UNT>PWD**
2. Press “OK” to start changing password

### 6.2.Real Time Clock (RTC)

Setting date and time is mandatory in order to use the time-related functionalities on the device (Tariff). Please notice that if no date and time are set, no timestamp will be available on the measured data.

D1M series meter also provides DST (Daylight Saving Time).

#### • RTC

CONF>UNIT>RTC

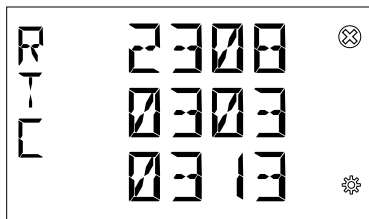

1. The format of **RTC** setting page is  
Year/Month  
Day/Hour  
Minute/Second
2. Setting sequence is  
year->month->day->hour->minute->second.

#### • DST

Disable or enable DST and set the start time (format: YYMMDDHH) of **DST**, and end time is the same.

CONF>UNIT> RTC>DST

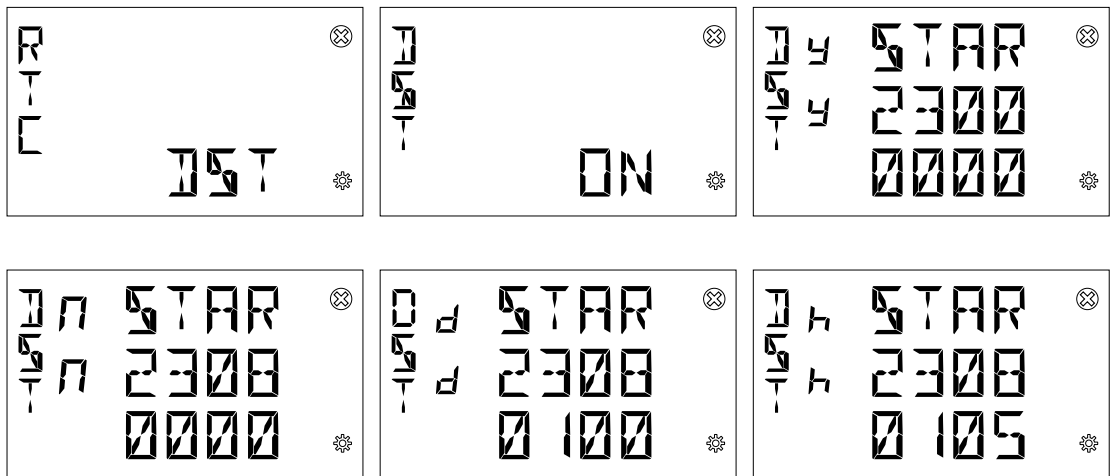

### 6.3. Wiring (WIR)

In order to configure the type of network it is needed to choose one of the available options according to the installation conditions.

CONF>ISTL>WIRI

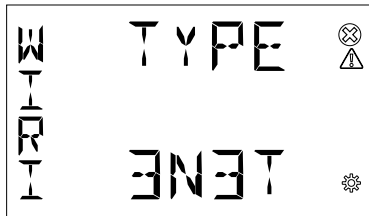

1. Scroll the list of fields “Up” or “Down”
2. Select one option by pressing “OK”

Type	Description
3N3T	Three-phase, four-wire and 3 CTs
3N1T	Three-phase, four-wire and 1 CT
3 3T	Three-phase, three-wire and 3 CTs
3 2T	Three-phase, three-wire and 2 CTs
3 1T	Three-phase, three-wire and 1 CT
2N2T	Two-phase, three-wire and 1 CT
1N1T	Single-phase, two-wire and 1 CT

### 6.4. CT ratio (CT)

D1M is capable to measure current only via indirect connection by means of current transformers CTs.../5A or .../1A.

It is needed to set the transformation ratio of the installed current transformers.

In order to configure the current transformers ratio, it is possible to set the primary (PRIM) and secondary (SEC) of the current transformer.

CONF>ISTL>CT

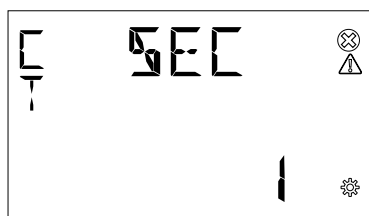
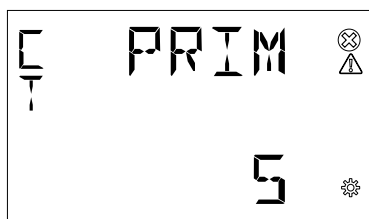

1. When the number of the primary CT is set, press Button “OK”
2. Use Button “Up” and Button “Down” to select the magnitude
3. Press button “OK” to confirm the setting of the primary CT
4. Press button “Down” to go to the setting of the secondary CT
5. Select the secondary CT among 1 and 5A
6. Press button “OK” to confirm the setting of the secondary CT

## 6.5.VT ratio (VT)

D1M is capable to measure voltage via direct connection up to 300 V (L-N), or via indirect connection by means of voltage transformers.

In order to configure the voltage transformer ratio, it is needed to enter manually the values of both primary (**PRIM**) and secondary (**SEC**).

### CONF>ISTL>VT

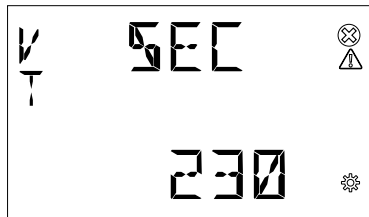
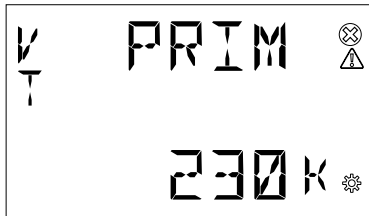
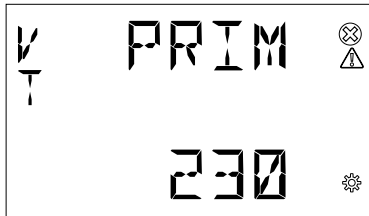

1. When the number of the primary VT is set, press Button **"OK"**
2. Use Button **"Up"** and Button **"Down"** to select the magnitude
3. Press button **"OK"** to confirm the setting of the primary VT
4. Press button **"Down"** to go to the setting of the secondary VT
5. When the number of the secondary VT is set, press Button **"OK"**
6. Press button **"OK"** to confirm the setting of the secondary VT

In case of direct insertion without voltage transformers, please set VT ratio as 230/230 (default).



## 7. Configuration (CONF)

When the user goes to the **CONF** section, Icon  will be displayed.

When entering the **CONF** section, in order to change any configuration of the device, it is mandatory to enter the password. It is needed to enter the password again when customer needs to re-operate after inactivity time.

In case of wrong entering of the password for three times in a row, user will have to wait for 5 minutes until he can enter the password once again.

In order to read only the configurations, it is possible to simultaneously press “**DOWN**” and “**Up**” buttons while entering password.

After the user enters the password to unlock the device, icon  will disappear.

**CONF** includes the following menus:

Menu	Description
UNIT	Settings related to the device itself
ISTL	Settings related to the installation conditions
I/O	Settings related to the pulse LED
ALARM	Definition of alarm conditions
TARF	Tariff Setting
COMM	Settings related to the embedded communication protocols of the D1M version
OTHR	Other settings

### 7.1. Unit (UNIT)

**UNIT** includes the following sub-menus:

Menu	Description
PWD(Password)	Change the existing password
RST(Reset)	Full or partial reset of the meter
INFO(Information)	Device information
RTC(Real time)	RTC and DST setting
BRT(Brightness)	Adjust the brightness of the display
ENSV(EnergySaving)	Inactivity time interval
ALOG(AuditLog)	Review audit logs
HOME PAGE	Home page and autoscroll setting
LED	LED parameter setting

#### Modify password (PWD)

PWD shares the same interface and setting way with password setting. For details, see “[6.1.Password for the first use \(PWD\)](#)”.

**CONF>UNIT>PWD**

**Reset (RST)**

If the user selects “YES” and presses Button “OK”, all parameters will be reset, i.e. restoring all parameters to their factory default.

**CONF>UNIT>RST**

RST sub-menu includes the following pages:

Menu	Description
RESET FACTORY	Reset and Clear everything, restore the device to the factory state except for the Audit Log.
Reset Energy	Clear register of all energy
Reset NOTF	Clear the logs of warning, error and alarm
Reset Avg/Max/Min	Reset and clear the data of Average, Maximum and Minimum
Reset GLOBAL	Complete reset of the device except for the settings and the audit log
Reset TIMR	Reset and clear Time Up CoUNITer to 0 and Time Down CoUNITer to the last set value

**• RESET FACTORY**

Reset Factory settings restores parameters to default values, including communication parameters, energy, alarms, CT/VT configuration, etc. Restore the device to the factory state except for the Audit Log.

**CONF>UNIT>RST>FACTORY**

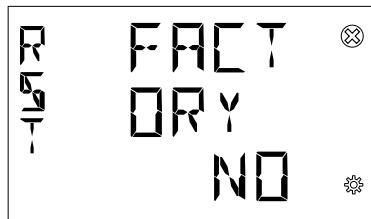

**• RESET ENRG**

Reset energy will clear the energy to 0.

**CONF>UNIT>RST>ENRG**

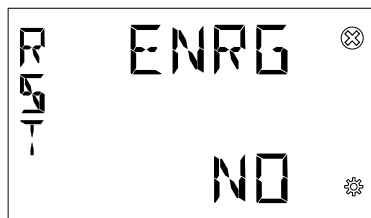

- **RESET NOTF**

All notification will be cleared after the reset notification, including alarms, warnings, and errors.

**CONF>UNIT>RST>NTF**

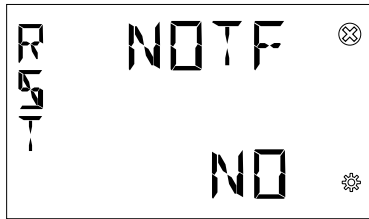

- **RESET Avg/Max/Min**

Reset and clear the data of Average, Maximum and Minimum

**CONF>UNIT>RST>AVG**

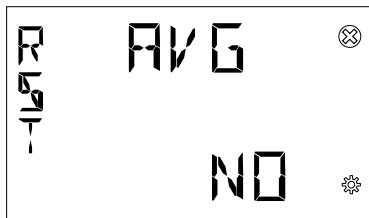

- **RESET Global**

Complete reset of the device except for the settings and the audit log, include notifications, timer, energy, Avg/Max/Min.

**CONF>UNIT>RST>GLOBAL**



- **RESET Timer**

Reset and clear Time Up Counter to 0 and Time Down Counter to the last set value.

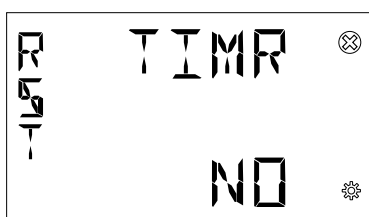

### Device information (INFO)

INFO includes firmware version, product model and peripheral functions, etc.

#### CONF>UNIT>INFO

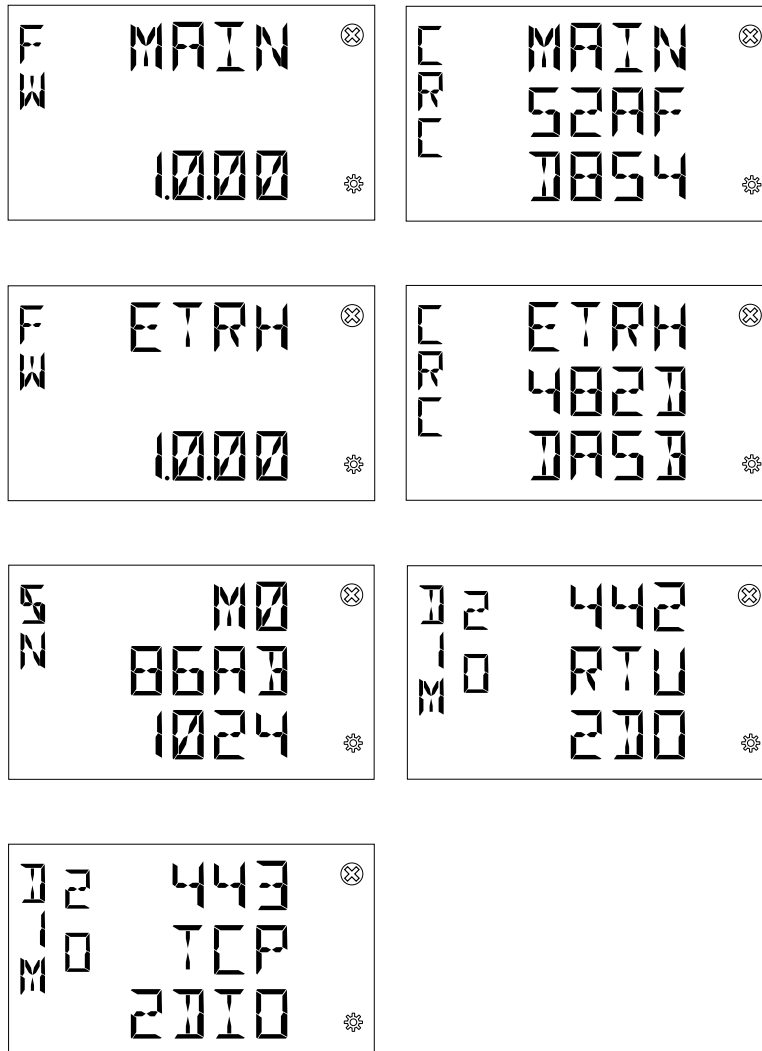

Menu	Description
FW	Firmware version, contain main board, ethernet board (D1M20 ETHERNET)
CRC	The CRC value of current firmware inside
SN	Serial Number
D1M 20	Device Type

### Real Time Clock (RTC)

RTC shares the same setting way with the same item under the first startup. For details, see “6.2.Real Time Clock (RTC)”.

### Brightness (BRT)

The parameter is used to adjust brightness of the display.

#### CONF>UNIT>BRT



The default of this parameter is 100%, and the adjustable range is 10%-100%.

### Energy Saving (ENSV)

In this menu it is possible to define the inactivity time in order to limit the device power consumption in no operation conditions. The range is from 1 ~ 60 minutes. After the inactivity time, it will display the homepage.

#### CONF>UNIT>ENSV.

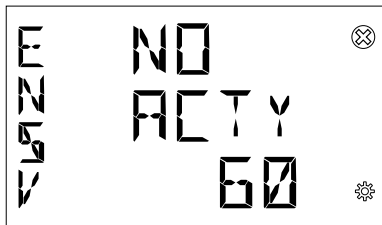

**Audit log (ALOG)**

In this part user can review all audit logs.

In the measurements area, select one to review. The audit log items contain the activities as below:

**CONF>UNIT>ALOG**

The audit log settings are displayed as follows:

- ALOG NUM**: 999
- TIME**: 2300, 03 10, 0000
- FW**: 23, 1001, 1.100
- VT PRIM**: 230K
- VT SEC**: 230
- CT PRIM**: 1000K
- CT SEC**: 5
- Wiring Type**: INIT
- Imported Active Energy**: 2503, 5498K
- Exported Active Energy**: 2503, 5498K

Quantities	Value
Trigger time	Year/month/day/hour/minute/second
FW Update successful	Upgrade counter and firmware version
VT Primary setting	VT primary value
VT Secondary setting	VT secondary value
CT Primary setting	CT primary value
CT Secondary setting	CT secondary value
Wiring Type setting	Wiring type
Total imported active energy	Active energy value
Imported active energy for tariff	T1/T2/T3/T4
Total exported active energy	Reactive energy value

**Home page (HOME PAGE)**

**HOME PAGE** can be set as the one of Summary, Phase Voltage, Line Voltage and Current page. It will turn to the home page which was set by users if no activities after inactivity time.

**CONF>UNIT>HOME PAGE**

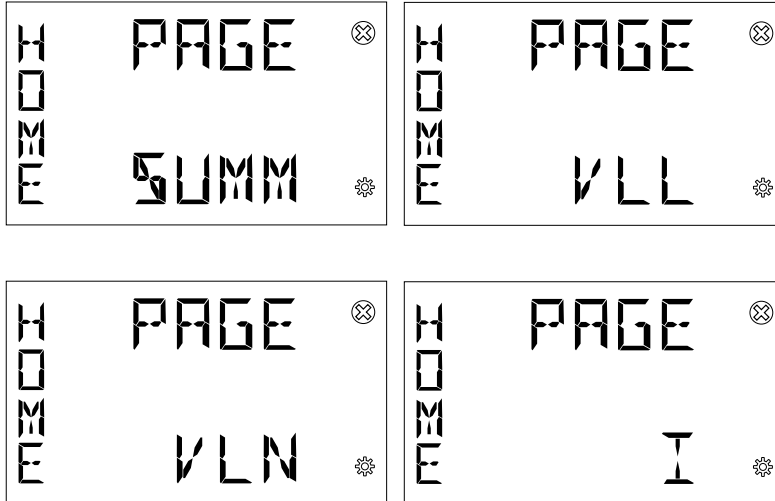

**• Auto Scroll pages:**

Auto Scroll pages can be set for an auto scroll time loop scrolling as below two modes:

- a) All Real Time measurement pages
- b) Phase measurements to three-phase-system measurements pages except for Summary

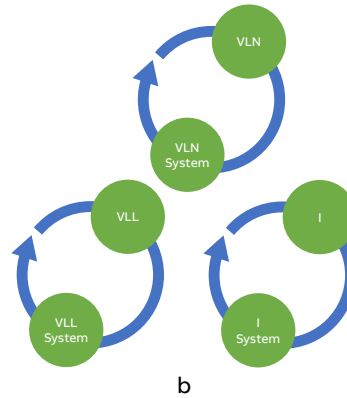
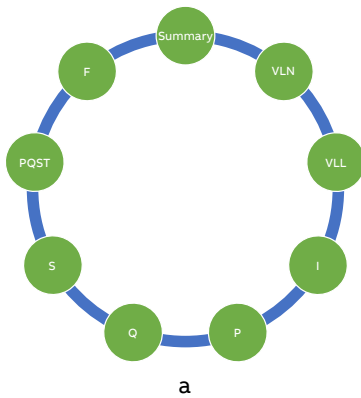

It will return a Homepage after timeout and display every few seconds.

If VLN/VLL is configured as the auto scroll page but the connection mode does not support the display of VLN/VLL, the display is not cyclic, the homepage is displayed on the Summary page.

The Homepage returns after a timeout. If the user presses the button to flip the page, the Realtime page is displayed.

**CONF>UNIT>HOMEPAGE**

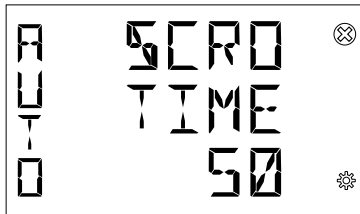
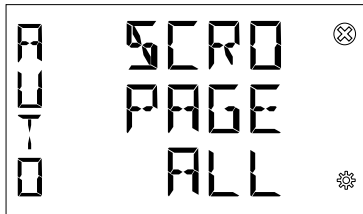
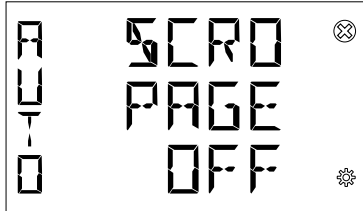

**LED energy indicator (LED)**

LED is used to indicate the speed of energy consumption. It can be configured to output Total Active Import Energy (IPEN), Total Active Export Energy (EPEN), Total Reactive Import Energy (IQEN), Total Reactive Export Energy (EQEN), Total Apparent Import Energy (ISEN), Total Apparent Export Energy (ESEN).

The pulse width can be configured between 10ms and 990ms, and it can be set via the HMI and communication.

The pulse should satisfy the following formula:

$$\text{Pulse width} \leq 1000 / (\text{Energy} * \text{Factor}) \text{ms}$$

The pulse factor range between energy and pulses is 1 to 99999999 pulse per energy, the energy type can be set as Active Energy, Reactive Energy or Apparent Energy, magnitude and unit can be MWh/MVarh/MVAh.

**CONF>UNIT>LED**

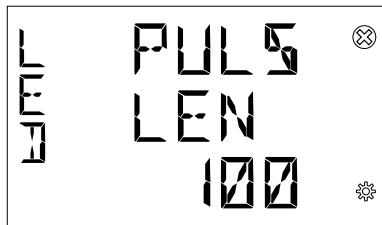
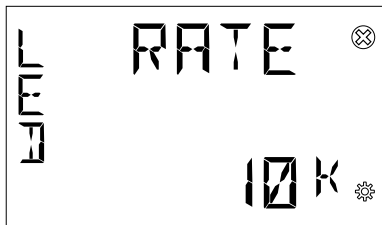
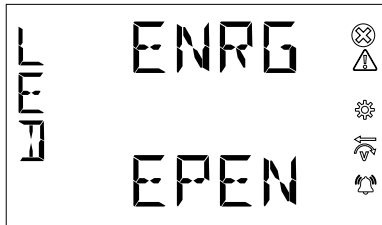



## 7.2.Installation (ISTL)

ISTL includes the following sub-menus:

Menu	Description
CT Primary	Set the primary ratio of current transformers for current measurement
CT Secondary	Set the secondary ratio of current transformers for current measurement
VT Primary	Set the primary ratio of voltage transformers for voltage measurement, if any
VT Secondary	Set the secondary ratio of voltage transformers for voltage measurement, if any
Wiring TYPE	Set the type of network and number of wires on which the device is installed

The three items above must be set during the first startup. For details, see “6.3.Wiring (WIR)”, “6.4.CT ratio (CT)” and “6.5.VT ratio (VT)”

## 7.3.Input/output (I/O)

In this section it is possible to configure I/O slots of the meter. D1M 20 series Power meter have two ports of DO and two ports of DI.

I/O includes the following sub-menus:

Menu	Description
DO	Digital Output
DI	Digital Input

### Digital Output (DO)

Each DO can be configured as **Alarm output**, **Communication output**, **Pulse output**, **Output ON** or **Output OFF**.

CONF>I/O>DO

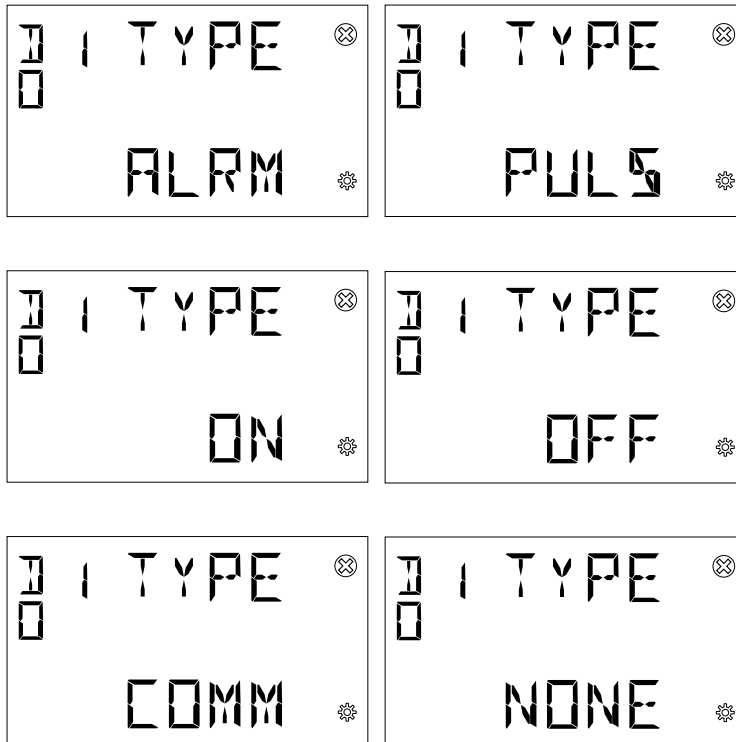

## Pulse output

Selecting **Pulse output**, the output is set as a pulse generator associated with a measured parameter. It is needed to consecutively set a measured parameter associated to the pulse output, the pulse ratio, and the pulse length.

Electricity Variable	Description
IPEN	Import active energy
EPEN	Export active energy
IQEN	Import Reactive energy
EQEN	Export Reactive energy
ISEN	Import Apparent energy
ESEN	Export Apparent energy
NONE	Nothing

- The pulse ratio could be set manually or selected from default values. The formula guiding this parameter setting is:

$$\text{Outing pulse} = X * \text{Energy (Wh/varh/VAh)}$$

X is the set value of pulse ratio.

Default values: 10/100/1000/5000 pulses for each kWh/kvarh/kVAh or 10/50/100 pulses for each Wh/varh/VAh.

Manual setting: 1 and 999999 pulses for each MWh/Mvarh/MVAh.

- The pulse width could be configured once DOs were configured as pulse output, and the two DOs follow the same setting of pulse length when they are all configured as pulse output.

Manual setting: 10 to 990ms.

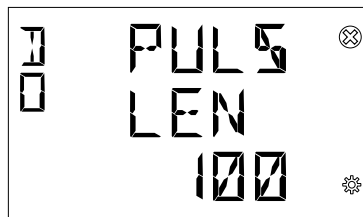
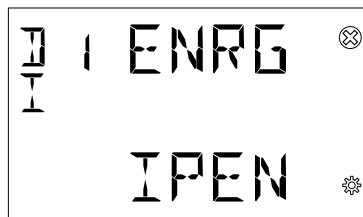
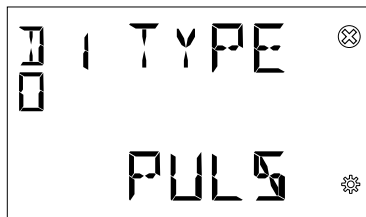

## Alarm output

Selecting **Alarm output**, it is mandatory to set up an alarm prior to setting an output as Alarm output. For alarm settings, please refer to chapter [“7.4.Alarms \(ALAM\)”](#).

## Always ON/OFF

Selecting Output **ON** / Output **OFF**, the output acts as a contact close / contact open.

Selecting Output **ON** the circuit is closed, selecting Output **OFF** the circuit is open.

For output connections, please refer to chapter [“4.3.Wiring diagrams”](#).

## Communication

Selecting **Communication** output, the output status is controlled directly via communication bus.

## Digital input (DI)

All DIs can be configured as **Pulse Input** or **Tariff Input**.

Menu	Description
Pulse Input	Count the pulses and calculate the energy according to the pulse factor
Tariff Input	Both the 2 ports are used to indicate the current tariff

### Pulse Input

Selecting **Pulse Input**, it is needed to consecutively set a pulse ratio associated to the pulse counter, and then a unit of measurement to be associated to the pulses.

The pulse ratio is set manually between 1 to 999999.

Electricity Variable	Description
IPEN	Import active energy
EPEN	Export active energy
IQEN	Import Reactive energy
EQEN	Export Reactive energy
ISEN	Import Apparent energy
ESEN	Export Apparent energy
NONE	Nothing

CONF>I/O>DI

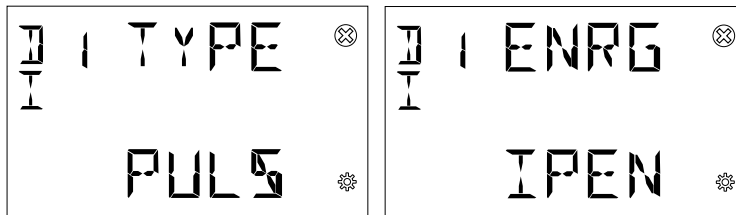

### Tariff Input

These 2 input ports can be set for **tariff input** together in “7.5.Tariff (TARF)”, and it cannot be changed in “Digital I/O Setting” anymore.

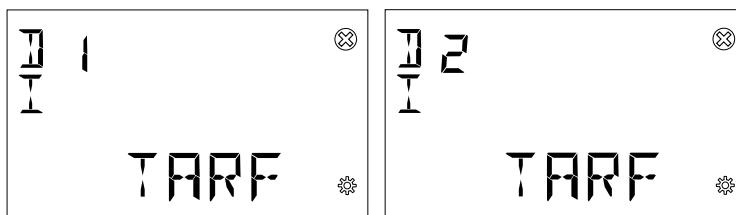

### 7.4.Alarms (ALAM)

**ALARM** configuration is used to get info on threshold violations of specific parameters. When the measurement quantity exceeds the limit, an alarm will be given to prompt users to make corresponding treatment measures in time.

Each alarm can only be triggered when certain conditions are met. The following graph describes the process of triggering and releasing an alarm:

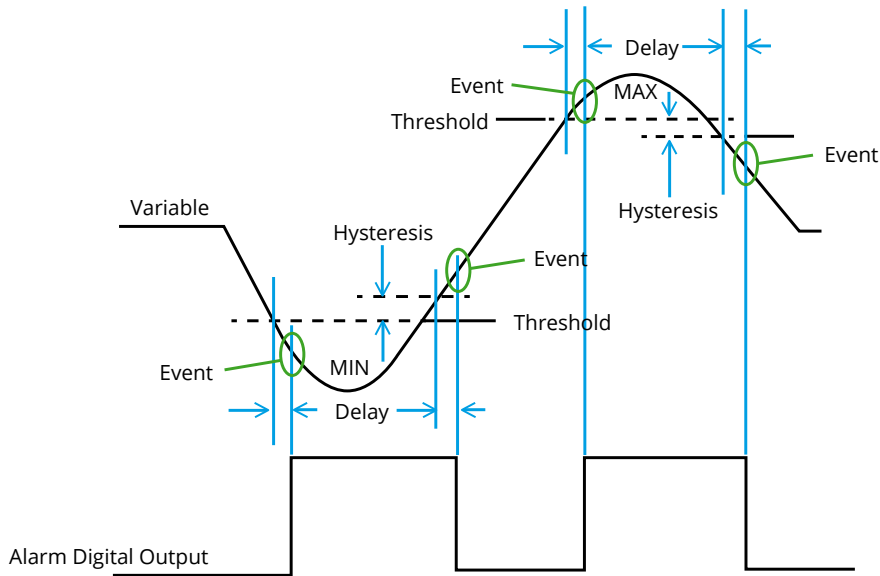

When the value of the alarm variable exceeds the threshold and the delay, the alarm will be generated; and when the alarm variable recovers to the normal range and exceeds the hysteresis and delay, the alarm will be released. Alarm can be connected to certain DO to control the alarm signal output at the DO. If the alarm is stored in flash, it can be viewed later in the read data menu. When the device is in alarm state, ICON 📢 will be displayed.

Each D1M 20 provides up to 15 alarms; following parameters are available:

Menu	Description
Menu	Description
NUM	Select which alarm will be edited, max 15 alarms can be selected
VARIABLE	Select alarm variable
PHASE	Select the phase of alarm variable
TYPE	Type of alarm: cross-up (MAX) or cross-down (MIN)
SETPOINT	Set threshold
DELAY	Delay time
HYSTERESIS	Set hysteresis
LOG	Storing the alarm
PORT	Select digital output port for alarm

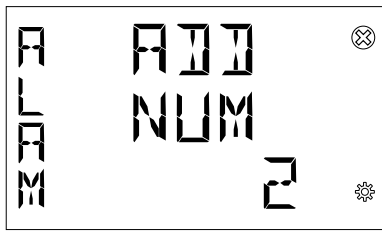
**NUM****CONF>ALAM>NUM**

- “Add” indicates that the alarm is not yet present. If it needs to be added, press the button “OK” to go to the event and configure the subsequent parameters.

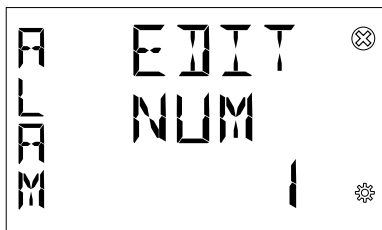

- “Edit” indicates that the alarm is already present. If it needs to be modified, press the button “OK” to go to the event and modify the configurations.

If certain event needs to be deleted from the alarm list, the alarm variable is selected as “NONE”. For details, see “**VARIABLE**”.

**VARIABLE**

Select one variable as alarm variable or event variable.

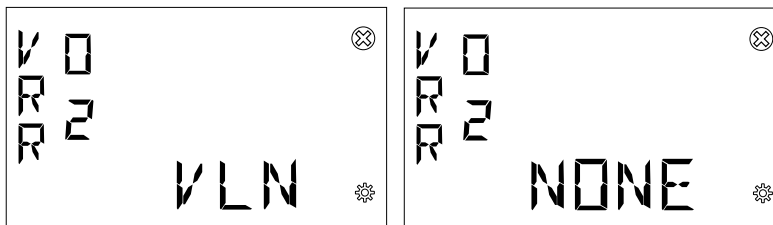
**CONF>ALAM>VRR**

Variable	Description
VLN	Phase voltage
VLL	Line voltage
I	Phase current
IN	Neutral current
P	Active power
Q	Reactive power
S	Apparent power
PT	Total active power
QT	Total reactive power
ST	Apparent power
PF	Power factor
PFT	Total power factor
F	Frequency
THDV	Total harmonic distortion of phase voltage
THDI	Total harmonic distortion of current
THDU	Total harmonic distortion of line voltage
None	Nothing

**PHASE**

When a variable is selected, a specific **phase** of the variable needs to be selected.

**CONF>ALAM>PHSE**

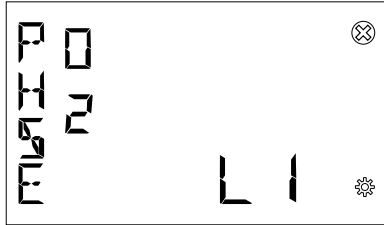

Phase	Description
L1	Phase 1
L2	Phase 2
L3	Phase 3
TOT	Total phase (when PT/QT/ST/PFT is selected variable)

Different variables contain different phases, so the phase selection depends on the variable selected.

**TYPE**

**TYPE** includes MAX (cross-up event) and MIN (cross-down event).

**CONF>ALAM>TYPE**

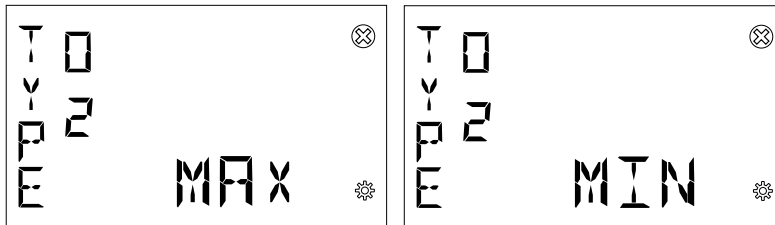

## SETPOINT

**SETPOINT** includes numerical value and magnitude. Different variables correspond to different thresholds, magnitudes, and units, and you need to select variables before setting SETPOINT.

Variable	Value range
Active Power	0~9999MW
Active Power Total	0~9999MW
Reactive Power	0~9999MVar
Reactive Power Total	0~9999MVar
Apparent Power	0~9999MVA
Apparent Power Total	0~9999MVA
Power Factor	0.000~0.999
Current	0.000~(50*120%)kA
Neutral Current	0.000~(50*120%)kA
Phase Voltage	0.000~(750*120%)kV
Line Voltage	0.000~(750* $\sqrt{3}$ *120%)kV
Current THD	0~99.9 %
Phase Voltage THD	0~99.9 %
Line Voltage THD	0~99.9 %
Frequency	0~70Hz

Notes: The upper limit of each setpoint is calculated based on the maximum values of CT and VT primary and increase redundancy by 20% except for some particular variables.

### CONF>ALAM>STPT

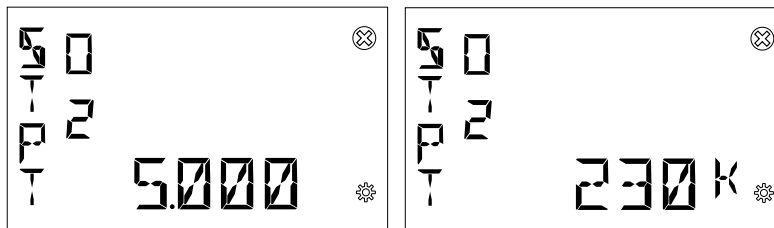

After the number is set, it is needed to use Button “Up” and Button “Down” to adjust the magnitude.

## HYSTERESIS

**HYSTERESIS** is a percentage value, and its setting range is 0%-50%.

### CONF>ALM>HYST

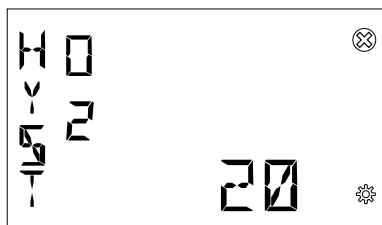

**DELAY**

**DELAY** is used to verify whether the variable value really exceeds the limit or is recovered, and its setting range is 0~900s.

**CONF>ALAM>DELAY**

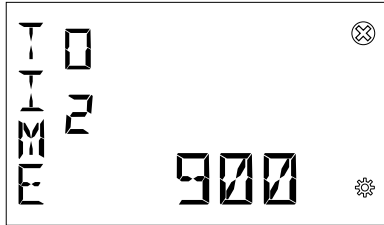

**LOG**

All alarms are set by default in log mode, which means that alarms are stored in flash memory when the alarm is triggered.

**CONF>ALAM>LOG**

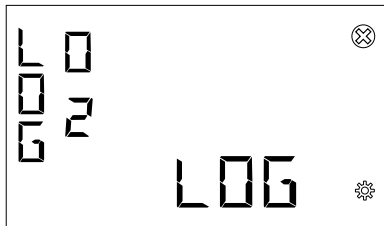

**PORT**

Each alarm event can be connected with certain DO, and different alarms can be connected to the same DO.

**CONF>ALAM>PORT**

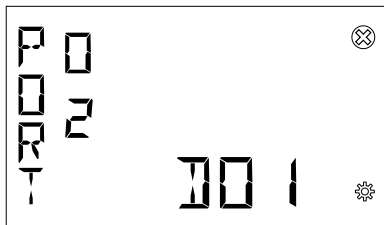

- The optional DOs include DO1, DO2 and NONE.

Only the DOs configured as alarm output can appear in the list. For details, see [“7.3.Input/output \(I/O\)”](#).



### 7.5.Tariff (TARF)

There are up to 4 tariffs to monitor consumption in different time phase. If select RTC as the tariff source, it provides 3 kinds of day-type with configurable tariff configurations.

**TARIF** menu as below:

Electricity Variable	Description
Tariff source	Selected from 4 options: OFF (disable)/COMM(communication)/DI (digital input)/RTC (real time clock)
Tariff RTC set	Set the day-type (special day/ weekday/ weekend) Set the tariff configurations for different day-type.
Current tariff	Read only. T1...T4.

**TARIF** menu tree as below:

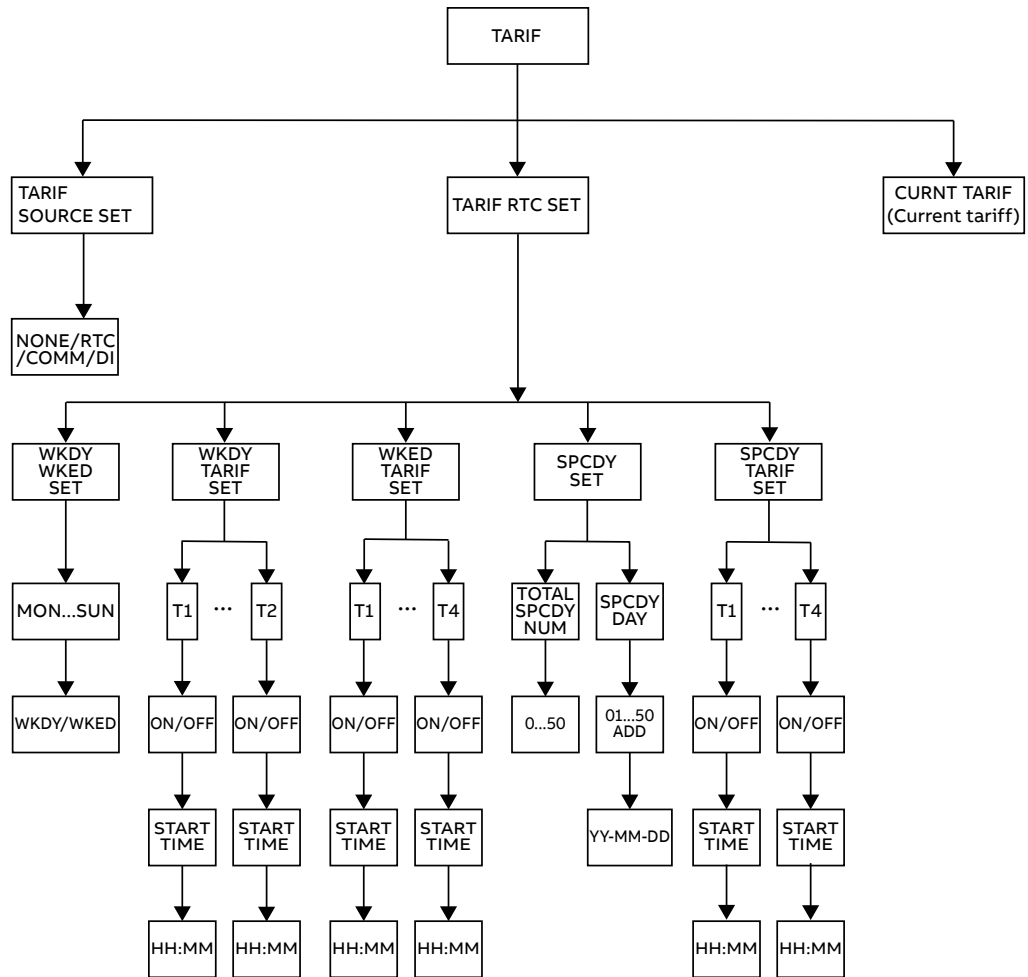

### Tariff source

It is possible to select from 4 options include NONE (disable)/COMM(communication)/DI (digital input)/ RTC (real time clock).

#### CONF>TARF>TARF SOURCE

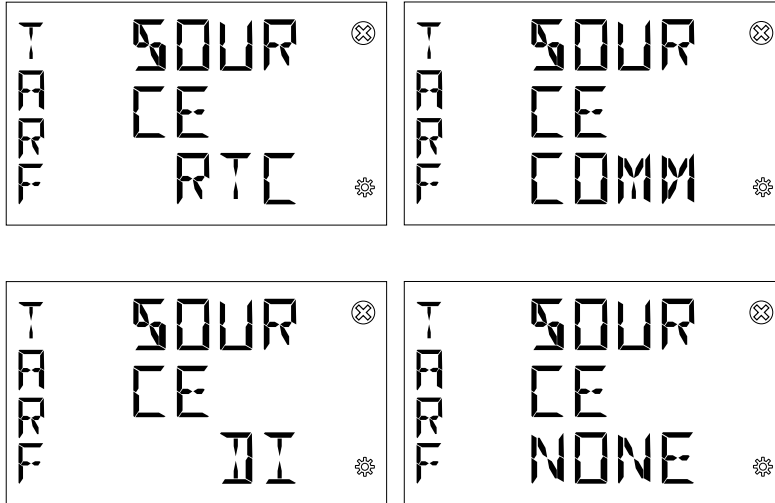

### Tariff RTC set

If user select tariff source as RTC, tariff RTC menu will be valid.

#### CONF>TARF>SET RTC

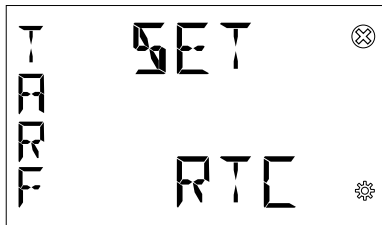

• **Set Day Type**

Set Monday/Tuesday/Wednesday.../Sunday as weekday or weekend.

CONF>TARF>SET RTC>SET DAY TYPE

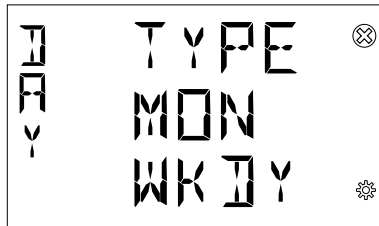
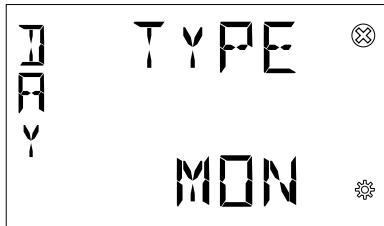
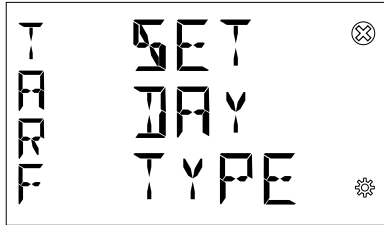

...

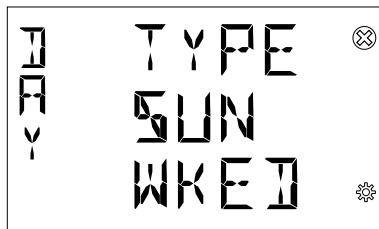
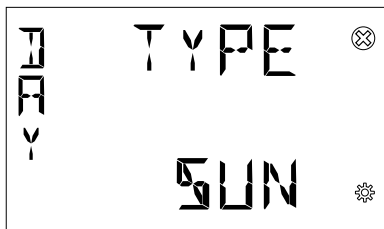

• Set weekday time

Enable or disable T1 and set start time(HHMM) of T1, same as T2,T3,T4.

CONF>TARF>SET RTC>SET WKDY TIME

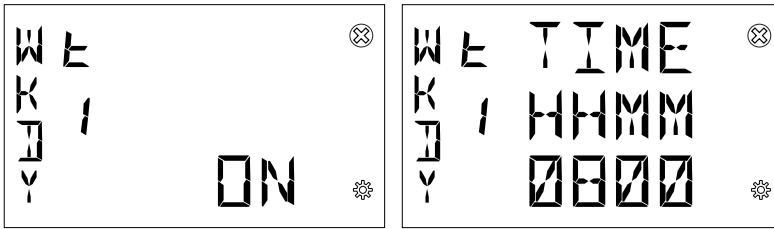
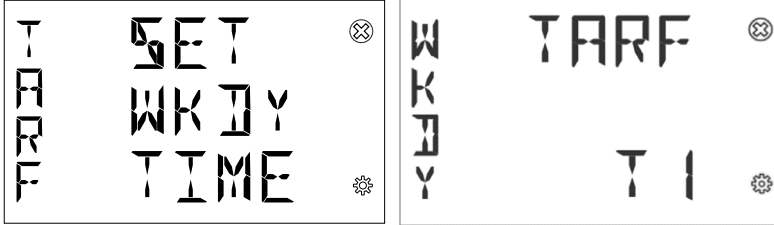

• Set weekend time

Enable or disable T1 and set start time(HHMM) of T1, same as T2,T3,T4.

CONF>TARF>SET RTC>SET WKED TIME

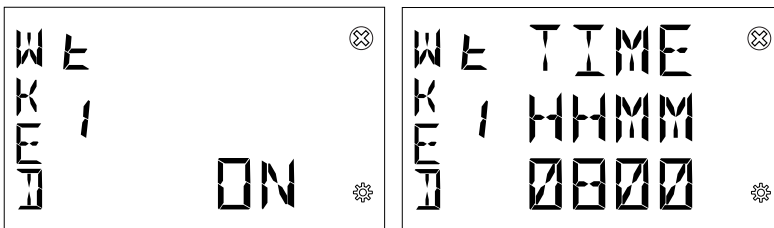
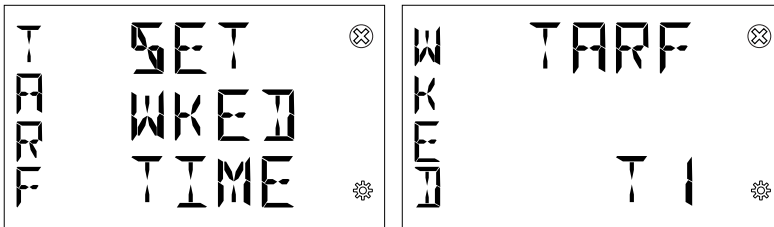

• Set Special Day

Set the total number of special day (0-50).

CONF>TARF>SET RTC>SET SPECDAY>TOT

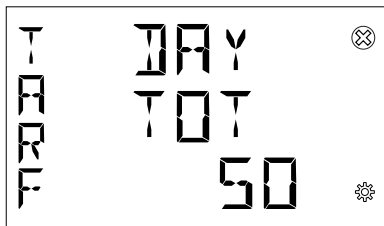
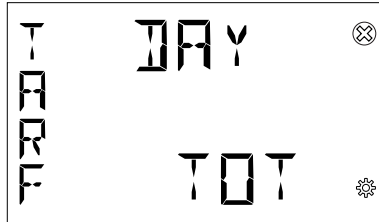
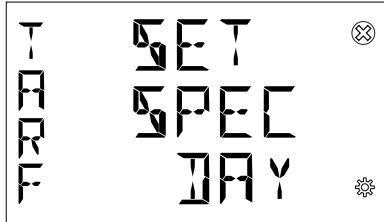

After setting the total number of special day, add special day (SPCE DAY) one by one in the format: YY-MM-DD.

CONF>TARF>SET RTC>SET SPECDAY>DAY DATE

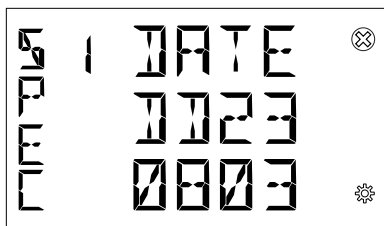
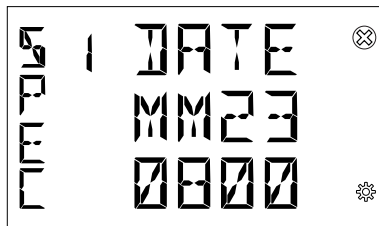
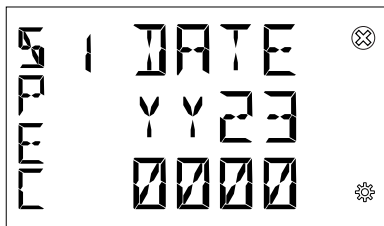
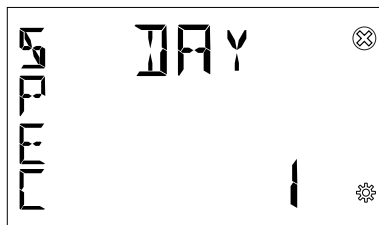

And then enable or disable special day T1 and set start time(HHMM) of T1, same as T2,T3,T4

**CONF>TARF>SET RTC>SET SPEC TIME**

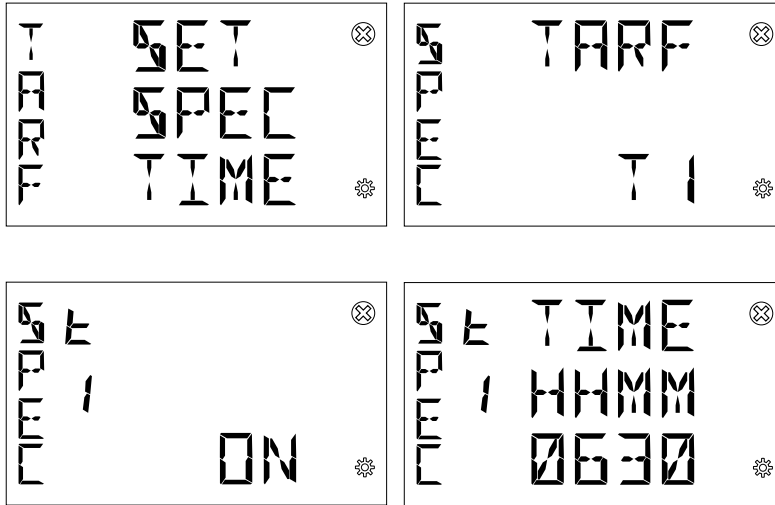

**Current tariff**

User could read the tariff (NONE/T1/T2/T3/T4) used currently.

**CONF>TARF>CURRENT**

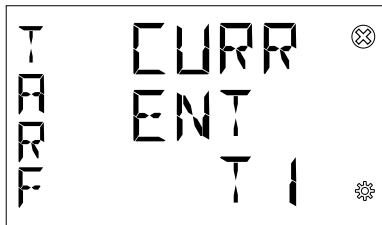



## 7.6.Communication (COMM)

**Comm** menu allows to set all the parameters related to the communication protocol available for a specific product version. The embedded communication protocol varies according to the different product versions. Please refer to “3.3.Versions” for the details on the embedded communication protocols.

Based on product version following configuration menu is available:

Communication Protocol	Parameter	Description
Modbus RTU	ADDR	Bus address
	BAUD	Baud rate
	BYTE	Byte format
	DHCP	Enable/Disable DHCP function
Modbus TCP/IP	IP	IP address
	MASK	Subnet mask
	GW	Default Gateway

In the communication process, whichever communication mode is selected, when the device receives data, Icon  will appear and flicker; and when the device sends data, Icon  will appear and flicker.

Enable communication set, the configure menu will be valid.

CONF>COMM



Modbus RTU (D1M 20 Modbus)

### • Baud rate (BAUDRATE)

**BAUDRATE** represents data transmission baud rate. The higher the **BAUDRATE**, the faster the data transmission.

CONF>COMM>BAUD

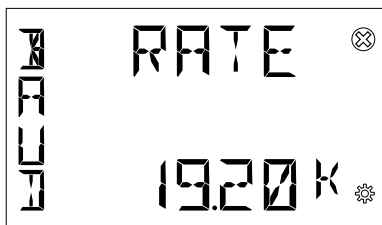

The optional Baud rates include 9600, 19200, 38400, 57600 and 115200 bps.

• **Byte format (BYTE)**

BYTE comprises three parts – bits per byte, parity bit and stop bit.

**CONF>COMM>PARITY**

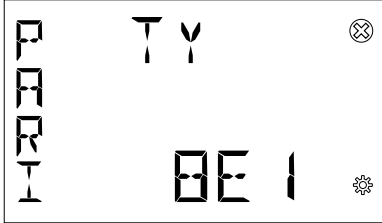

The optional byte formats include:

BYTE	Description
8E1	8 even parity bits and 1 stop bit
8O1	8 odd parity bits and 1 stop bit
8N1	8 No Parity bits and 1 stop bit

• **Address (ADDR)**

For the devices that adopt the Modbus RTU protocol, a unique address on the bus needs to be set.

**CONF>COMM>ADDR**



The address range is 1-247.



## Modbus TCP/IP (D1M 20 Ethernet)

### • DHCP

If **DHCP** is set as “**YES**”, it indicates that the IP address and subnet mask assigned by the host will be used.

#### CONF>COMM>DHCP

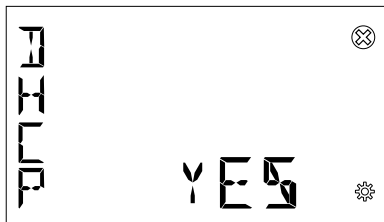

The default state of DHCP is “**NO**”, i.e. turned off.

### • IP

**IP** comprises 4 segments. Each time Button “**OK**” is pressed, the next segment can be set.

#### CONF>COMM>IP

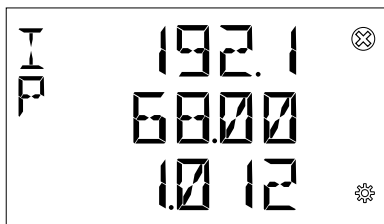

The default IP address is: 192.168.1.12.

The device and the host must share the same network, or their communication is not possible.

- **MASK**

**MASK** indicates the LAN segment. Only the devices that have the same subnet mask within the same LAN can communicate with each other.

**CONF>COMM>MASK**

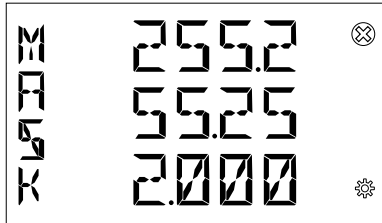

The default MASK is: 255.255.255.0.

- **GW**

The default **GW** is the node address that forwards the data package to other networks.

**CONF>COMM>GW**

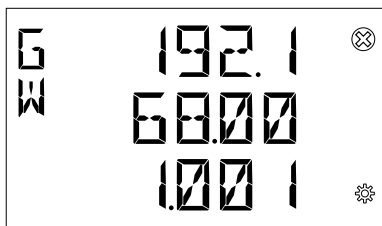

The default GW is: 192.168.1.1.

### 7.7.Other (OTHR)

There are some **other** functions can be set, following settings are available.

Setting	Description
Average Time Interval	Calculate the Average/Maximum/Minimum in Average Time Interval.
Time Count Down Setting	Count down start from this time was set.
CO2 Equivalence	Converse the Active Energy Import Total to CO2
Currency Equivalence	Converse the Active Energy Import Total to Currency

#### CONF>OTHR

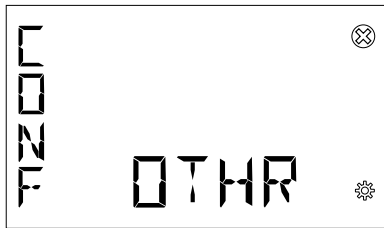

#### Average Time Interval(AVG)

**AVG** needs the user to set a calculation period (in minutes). The range of Average Time Interval is 1~60 minutes.

#### CONF>OTHR>AVG TIME

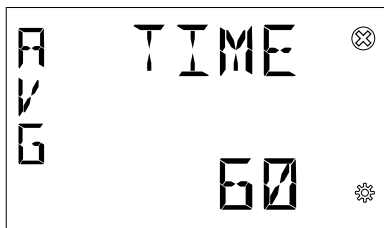

#### Time Count Down Setting

Set Count down time start from now. Default value is 1 year(8760 hours), and the maximum value can be set is 3 years.

#### CONF>OTHR>TIME DOWN

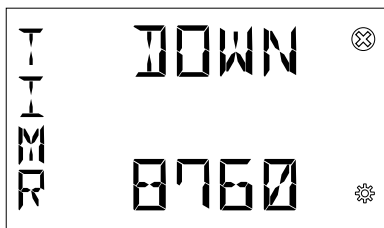

### CO2 Equivalence

Convert the Active Energy Import Total to CO2. The factor between the Active Energy Import Total and CO2 range is 0.001~9.999Kg/kWh.

CONF>OTHR>EQUI CO2

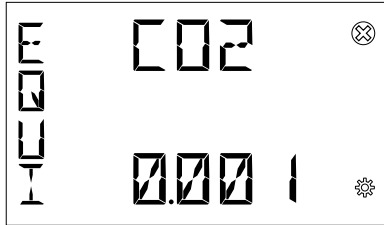

### Currency Equivalence

Convert the Active Energy Import Total to Currency. The factor between the Active Energy Import Total and Currency range is 0.001~99999.999Currency/kWh.

CONF>OTHR>EQUI CURY

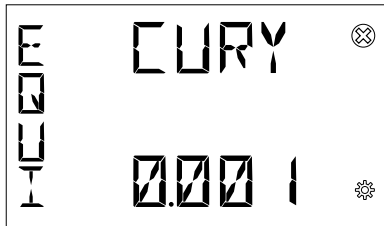

## 8. Data reading (READ)

**READ** section allows to visualize all the parameters measured by D1M.

Specifically, it includes the following menus:

Menu	Description
REAL	Real-time measurements
ENRG	Energy measurements
PWQT	Power quality
AVG	Average of measurement variable
MAX	Maximum value of measurement variable
MIN	Minimum value of measurement variable
I/O	State of digital input/output port
NOTF	Notification message
PWOF	Power off
TIMR	Timers

Specifically, in the menus: “REAL”, “AVG”, “MAX” and “MIN”, the unit and the magnitude of measurement items are put as alternating values periodically displayed like below:

e.g.1: If the measurement phase voltage is 100V, the display will show:

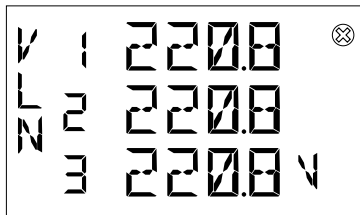

e.g.2: If the measurement phase voltage is 100kV, the display will show:



Measurement units will not be show on "PQST" page due to limited digits, only magnitude will be shown

e.g.3: If the measurement value magnitude is “K”, the display will show:

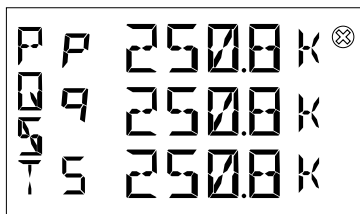

In the menu “ENRG”, the measurement item and unit are put as alternating periodically displayed like below:

e.g.4:



### 8.1.Realtime (REAL)

REAL means the real-time data of the current electric energy, including the following items:

#### READ>REAL

SUMM	V	2500.0 V	VLN	1	2200.0
	I	2500.0 A		2	2200.0
	P	2500.0 W		3	2200.0 V

VLL	1	3800.0	I	1	2500.0
	2	3810.0		2	2500.0
	3	3810.0 V		3	2500.0 A

IN	0.199 A		P	1	2500.0
				2	2500.0
				3	2500.0 W

Q	1	2500.0 V	S	1	2500.0
	2	2500.0 A		2	2500.0 V
	3	2500.0 R		3	2500.0 A

PQST	P	2500.0	F	50.4	
	Q	2500.0		Z	
	S	2500.0			

REAL	Measurement Unit	Description
SUMM	V, A, W	Summary measurements, average of 3 phases VLL, average of 3 phases I, and active power total
VLN	V	Phase voltage
VLL	V	Line voltage
I	A	Current
IN	A	Neutral current; when WIRI is selected as '3 3T', '3 2T', '3 1T' or '1N1T', this data is absent
P	W	Per phase active power; when WIRI is selected as '1N1T', this data is absent
Q	VAR	Per phase reactive power; when WIRI is selected as '1N1T', this data is absent
S	VA	Per phase apparent power; when WIRI is selected as '1N1T', this data is absent
PQST	W, VAR, VA	Total active, reactive, apparent power
F	Hz	Frequency

8.2. Energy (ENRG)

READ>ENRG

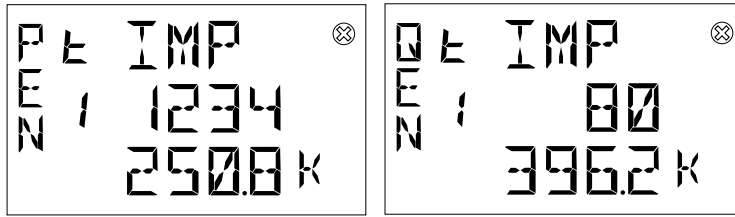

...

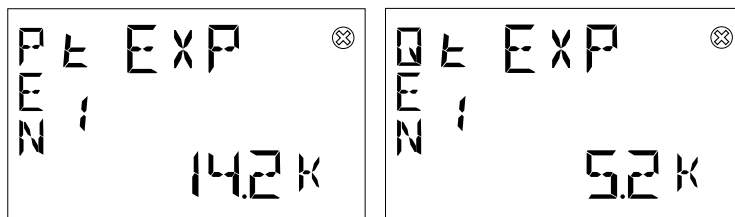
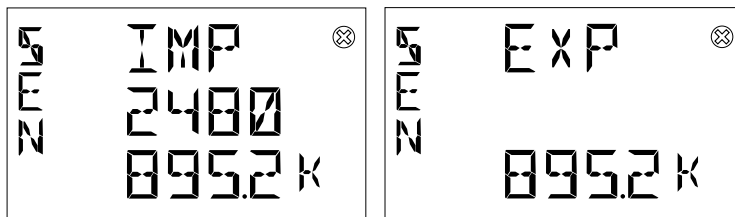
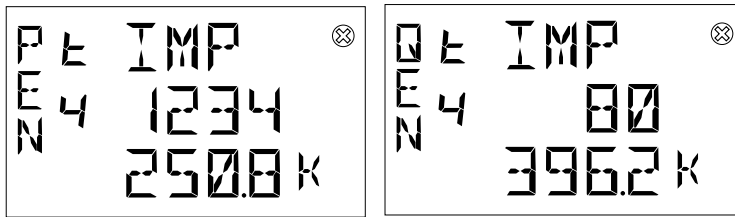

...

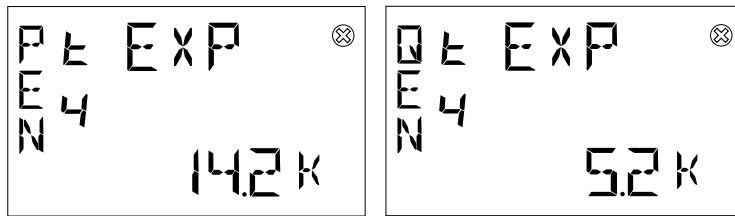

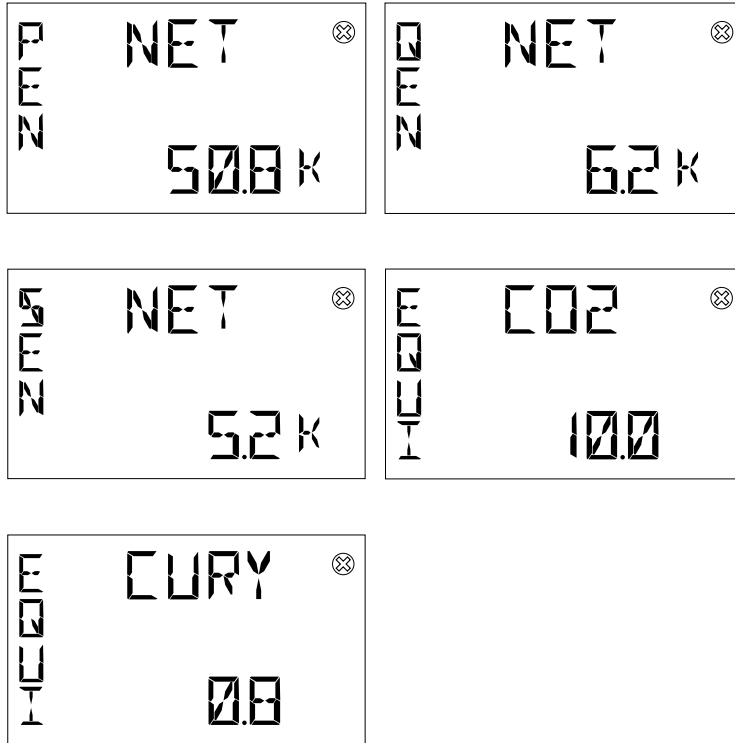

ENRG	Measurement unit	Description
T1+PEN	Wh	Tariff T1 total imported active energy
T1+QEN	VARh	Tariff T1 total imported reactive energy
T2+PEN	Wh	Tariff T2 total imported active energy
T2+QEN	VARh	Tariff T2 total imported reactive energy
T3+PEN	Wh	Tariff T3 total imported active energy
T3+QEN	VARh	Tariff T3 total imported reactive energy
T4+PEN	Wh	Tariff T4 total imported active energy
T4+QEN	VARh	Tariff T4 total imported reactive energy
+SEN	VAh	Total imported apparent energy
- SEN	VAh	Total exported apparent energy
T1-PEN	Wh	Tariff T1 total exported active energy
T1-QEN	VARh	Tariff T1 total exported reactive energy
T2-PEN	Wh	Tariff T2 total exported active energy
T2-QEN	VARh	Tariff T2 total exported reactive energy
T3-PEN	Wh	Tariff T3 total exported active energy
T3-QEN	VARh	Tariff T3 total exported reactive energy
T4-PEN	Wh	Tariff T4 total exported active energy
T4-QEN	VARh	Tariff T4 total exported reactive energy
PEN NET	Wh	Net active energy
QEN NET	VARh	Net reactive energy
SEN NET	VAh	Net apparent energy
Equivalent CO2		Convert the Active Energy Import Total to CO2.
Equivalent Currency		Convert the Active Energy Import Total to Currency.



### 8.3. Power Quality (PWQT)

READ>PWQT

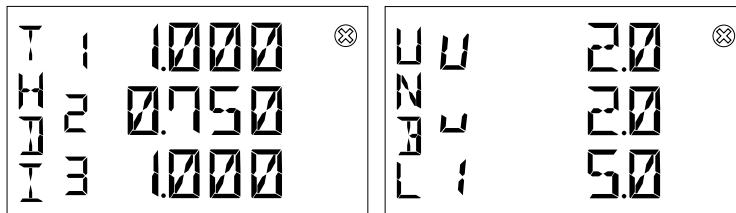
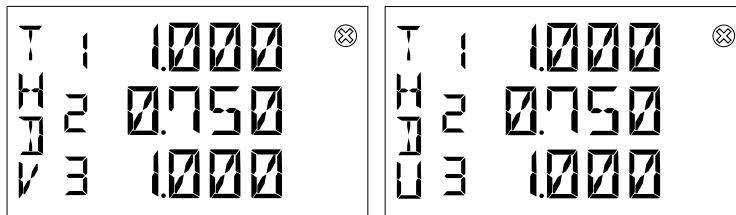
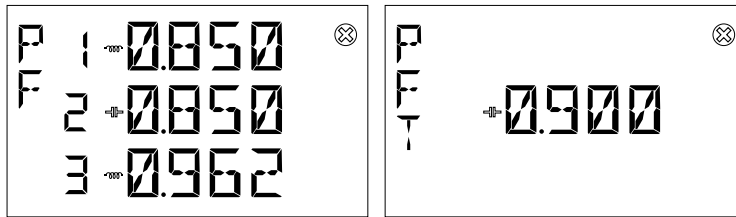

PWQT	Description
PF	Per phase power factor; when WIRI is selected as "3 3T", "3 2T", "3 1T" or "1N1T", this data is absent
PFT	Total power factor
THDV	Total harmonic distortion of phase voltage, when WIRI is selected as '3 3T', '3 2T', '3 1T', this data is absent
THDU	Total harmonic distortion of line voltage, when WIRI is selected as '3 3T', '3 2T', '3 1T' or '1N1T', this data is absent
THDI	Total harmonic distortion of current
UNBL	Unbalances values for line to neutral voltage (VLN), line to line voltage (VLL) and current (I); when WIRI is selected as '1N1T', this data is absent

Individual harmonics are present only via Modbus RTU and Modbus TCP/IP communication.

### 8.4.Average values (AVG)

AVG represents the average values for instantaneous parameters, calculated over the averaging time (see Average Time Interval sub-menu under “7.7.Other (OTHR)”), including the following items:

READ>AVG

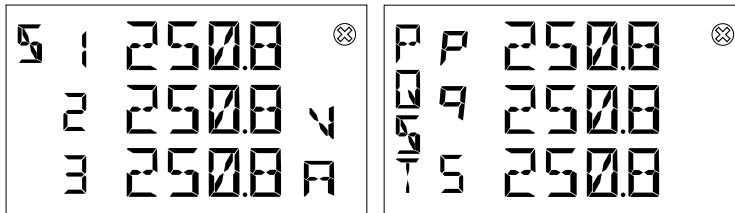
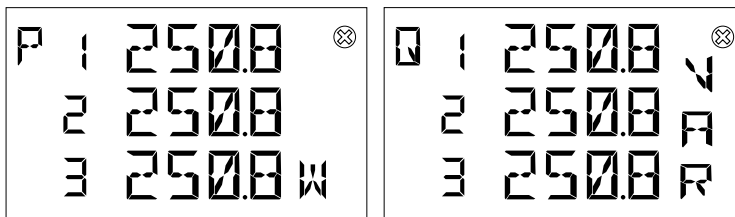
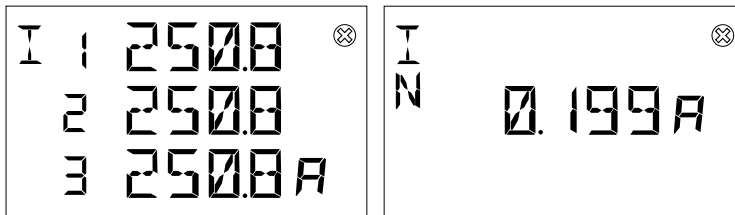
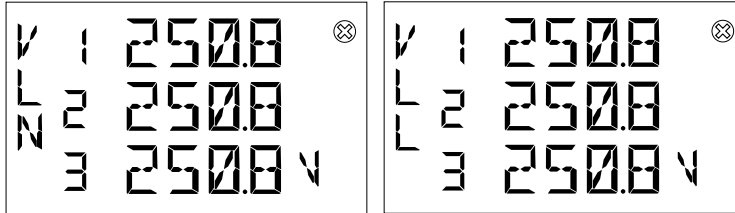

AVG	Measurement unit	Description
VLN	V	Average phase voltage
VLL	V	Average line voltage
I	A	Average current
IN	A	Average neutral current
P	W	Average per phase active power
Q	VAR	Average per phase reactive power
S	VA	Average per phase apparent power
PQST		Average total active, reactive, apparent power

## 8.5. Maximum values (MAX)

In order to access the **MAX** values, please press simultaneously “**OK**” and “**Up**” when in the parameter page in **READ/REAL**.

### READ>MAX

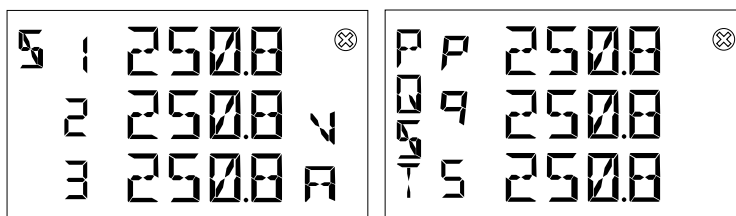
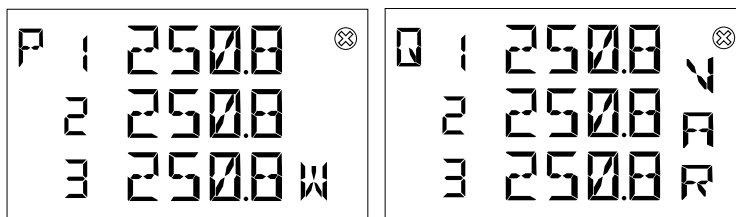
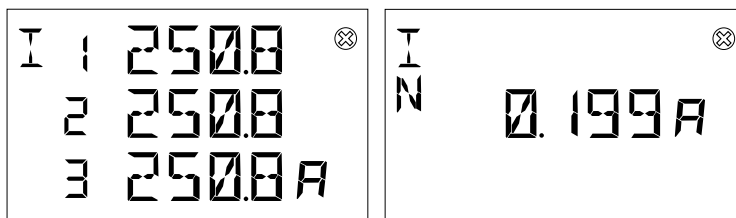
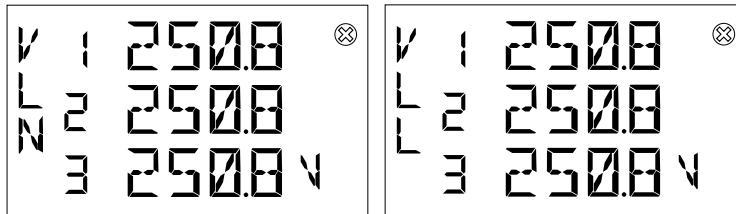

MAX represents the maximum values for:

MAX	Measurement unit	Description
VLN	V	Maximum phase voltage
VLL	V	Maximum line voltage
I	A	Maximum current
IN	A	Maximum neutral current
P	W	Maximum average per phase active power calculated over AVG time
Q	VAR	Maximum average per phase reactive power calculated over AVG time
S	VA	Maximum average per phase apparent power calculated over AVG time
PQST	W, VAR, VA	Maximum total active, reactive and apparent power calculated over AVG time

In order to reset all the MAX values, please press simultaneously “**OK**”, “**Up**” and “**Down**” when in any parameter page in **READ/REAL**.

## 8.6. Minimum values (MIN)

In order to access the **MIN** values, please press simultaneously “**OK**” and “**Down**” when in the parameter page in **READ/REAL**.

### READ>MIN

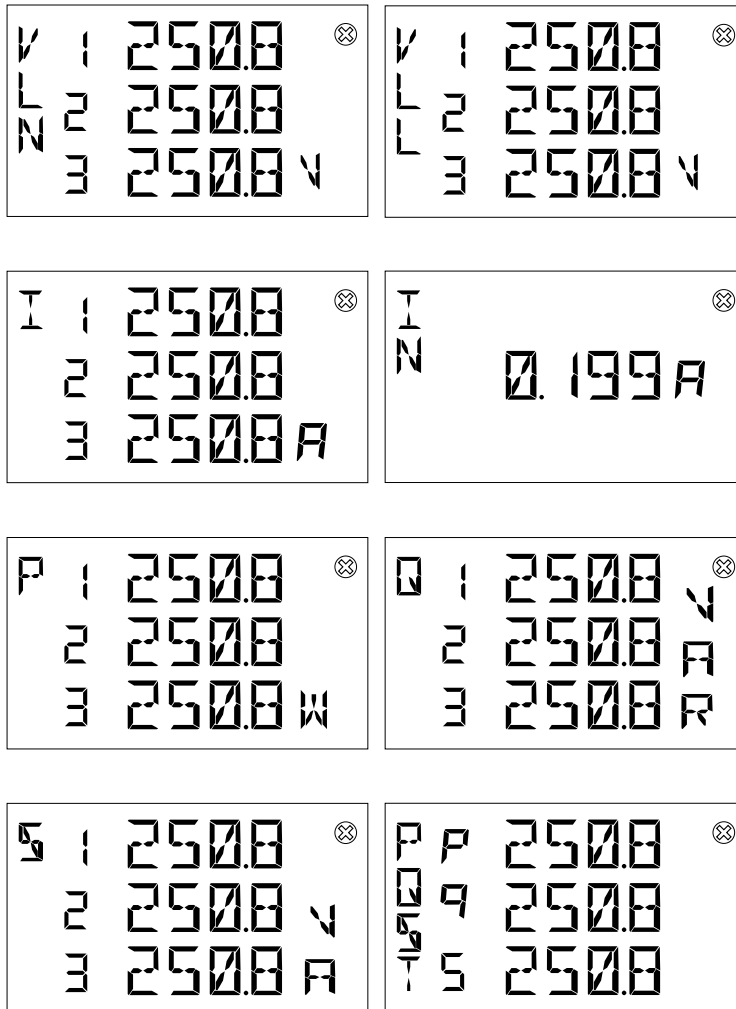

MIN represents the minimum values for:

MIN	Measurement unit	Description
VLN	V	Minimum phase voltage
VLL	V	Minimum line voltage
I	A	Minimum current
IN	A	Minimum neutral current
P	W	Minimum average per phase active power calculated over AVG time
Q	VAR	Minimum average per phase reactive power calculated over AVG time
S	VA	Minimum average per phase apparent power calculated over AVG time
PQST	W, VAR, VA	Minimum average total active, reactive and apparent power calculated over AVG time

In order to reset all the MIN values, please press simultaneously “**OK**”, “**Up**” and “**Down**” when in any parameter page in **READ/REAL**.

### 8.7.1/O

I/O sub-menu includes the reading of status and/or pulses for I/O, according to the product version:

Menu	Description
DO STATE	State of digital output port
DO1 PULSE	DO1 Pulse counter
DO2 PULSE	DO2 Pulse counter
DI STATE	State of digital input port
DI1 PULSE	DI1 Pulse energy
DI2 PULSE	DI2 Pulse energy

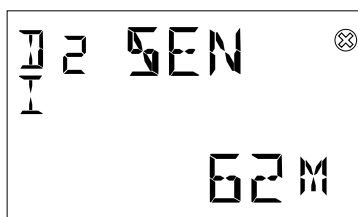
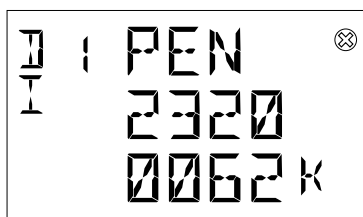
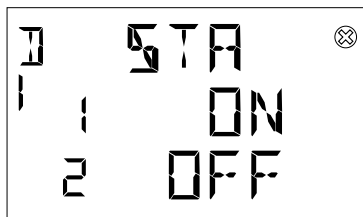
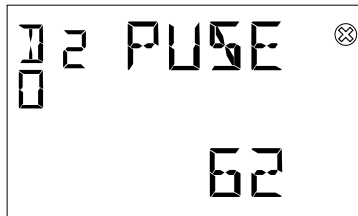
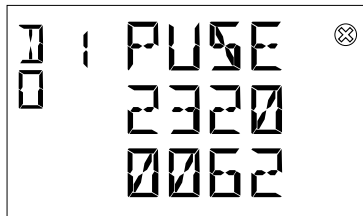
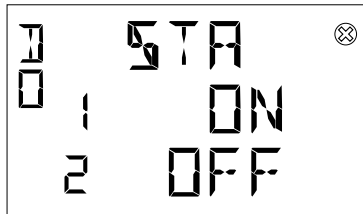

The state classifications include:

State	Description
ON	DO is on
OFF	DO is off
PULSE	Pulse output

### 8.8. Notifications (NOTF)

NOTF includes the following items:

Menu	Description
ALARM	Alarm list, Related to the alarm status and information
WARN	Warnings list, related to installation conditions and device settings.
ERROR	Errors list, related to the device and to its self-diagnostics.

#### Alarms (ALAM)



ALARM is generated based on the Alarm configured by the user. When the conditions meet the alarm parameters, the ALARM notification will be generated and Icon  will be displayed.

ALARM comprises alarm count and specific alarm message. The alarm message consists of alarm number, variable name, type, phase, trigger time and duration time.

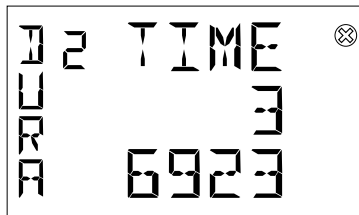
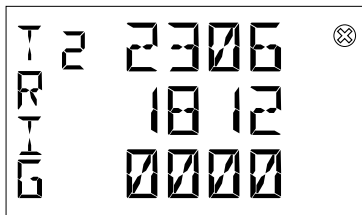
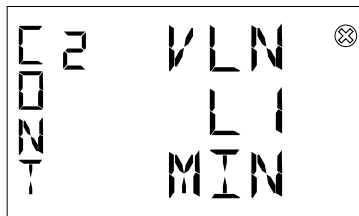
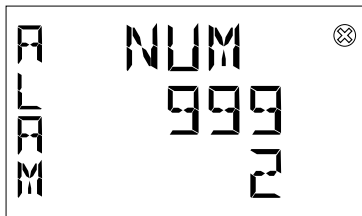
READ>NOTF>ALAM



### Warnings (WARN)

**WARN** is generated when the device detects the operating conditions. When there is a WARN notification, Icon  will be displayed; and when there is no warn messages, Icon  will disappear.

**WARN** comprises warn count and specific warn message.

#### READ>NOTF>WARN

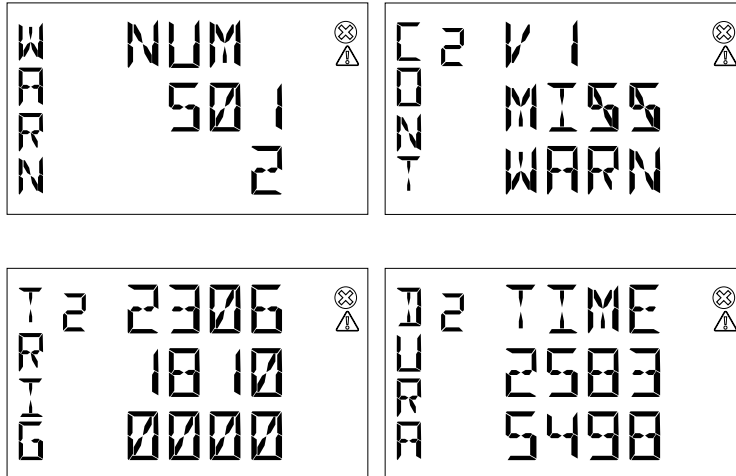

Warning	Definition
VOLT REVES	U1, U2 and U3 are inverse in 3 phases system
V1 MISS	Voltage 1 Missing
V2 MISS	Voltage 2 Missing
V3 MISS	Voltage 3 Missing
I1 MISS	Current 1 Missing
I2 MISS	Current 2 Missing
I3 MISS	Current 3 Missing
I1 REVES	Current 1 Reverse
I2 REVES	Current 2 Reverse
I3 REVES	Current 3 Reverse
I12 REVES	Current 1 with 2 Reverse
I23 REVES	Current 2 with 3 Reverse
I31 REVES	Current 3 with 1 Reverse
DATA UDIS	Measurement value too big cannot display on the displayer
USET PWD	Not Locked device, not set password
FREQ WRNG	Frequency out of the metering limit
USET DATA	Date not set
USET TIME	Time not set
V2 CONN	U2 connected for single phase wires setup
V3 CONN	U3 connected for single phase wires setup
I2 CONN	I2 connected for single phase wires setup
I3 CONN	I3 connected for single phase wires setup

### Errors (ERR)

**ERR** is generated when the device detects operating fatal conditions. When there is an ERROR notification, Icon (⊗) will be displayed and it will not disappear until the error is solved.

ERROR comprises error count and specific error message.

#### READ>NOTF>ERR

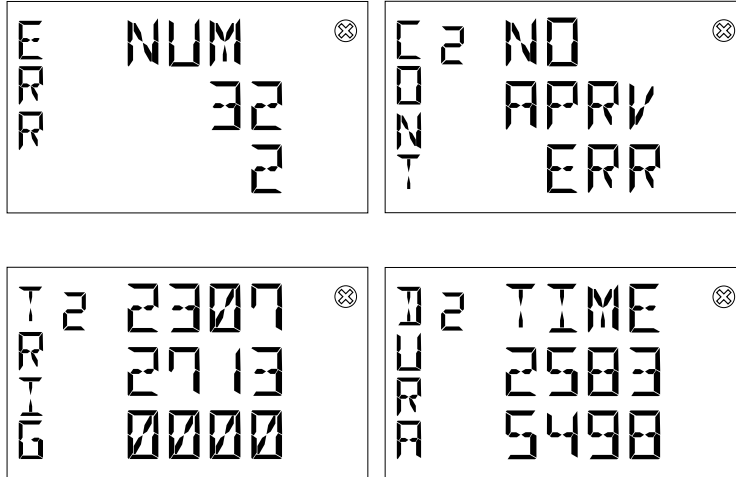

Error	Definition
ALOG ERR	Audit log error
FLSH ERR	Flash chip error or RAM memory CRC error
FW INV D	Firmware upgrade invalid image
EPRM ERR	Persistent storage error or EEPROM chip error
NO APRV	Product was not approved
RTC ERR	RTC Missing or data invalid
FWUP FAIL	Firmware upgrade error



### 8.9. Power Outage (PWOFF)

**PWOFF** is used to record the number and time of power outage. The maximum record number is 999.

READ>PWOFF

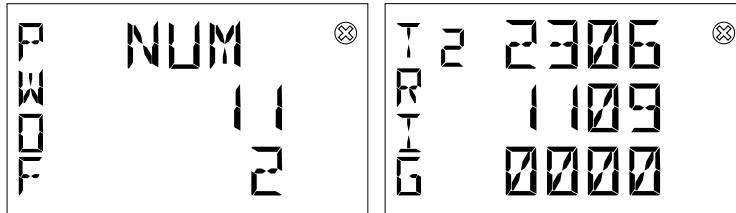

### 8.10. Timers (TIME)

**TIME** uses the hour of RTC to count these 2 counters below.

Error	Definition
TIMR UP	Count the total using time start from first commissioning. The maximum time up value is up to 99999999 hours(11415 years) and can be reset(see Reset (RST) sub-menu under "7.1.Unit (UNIT)").
TIMR DOWN	Count down start from this time was set. Default value is 1 year, and the maximum value can be set is 3 years. Also can be reset(see Reset (RST) sub-menu under "7.1.Unit (UNIT)").

READ>TIMR

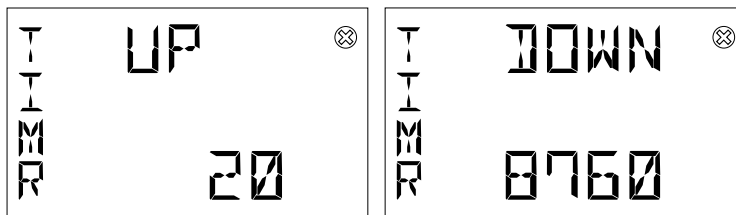

---

## 9. Conclusion

Thank you for using ABB D1M 20 series Power Meter and reviewing this user manual. In the future, if you encounter any problems, please contact ABB technical support, we will be happy to help you.



A series of horizontal dotted lines spanning the width of the page, intended for writing or drawing.



ABB LV Installation Materials Co. Ltd. Beijing  
Electrification Business Area  
No. 17 Kangding Street, Beijing  
Economic-Technological Development Area 100176  
[www.abb.com/low-voltage](http://www.abb.com/low-voltage)  
中国地区服务电话：400-820-9696

